

HOSE & FITTINGS HAND BOOK

TENTH EDITION



HIRSCH HYDRAULIC SERVICES

Unit 15, South Cape Industrial Park, 19 Leo Road, Diep River, Cape Town 7800

P.O. Box 334, Bergvliet 7864

Tel: (021) 706 7573

Cell: 0827287796 / 0833737556

Email: sales@hirschhyd.co.za

www.hirschhydraulics.co.za

HANDBOOK

TENTH EDITION

01-10-2022 (UPDATED 19-07-2023)

CODE	CONTENTS	PAGE
53P-	HYDRAULIC HOSE 1 + 2 WIRE	A 1
53P-	HYDRAULIC HOSE 4 WIRE	A 2
53P-	HYDRAULIC HOSE THERMOPLASTIC	A 3
53P-	HYDRAULIC HOSE SPIRAL GUARD	A 4
52P-	HYDRAULIC HOSE FERRULES / COLLARS / CLAMPS	B 1 - B 2
51P-	HYDRAULIC HOSE ENDS BSP & NPT	C 1 - C 2
51P-	HYDRAULIC HOSE ENDS JIC	C 3 - C 4
51P-	HYDRAULIC HOSE ENDS METRIC STANDPIPE	C 5
51P-	HYDRAULIC HOSE ENDS METRIC LIGHT & HEAVY	C 6 - C 7 - C 8
51P-	HYDRAULIC HOSE ENDS ORFS	C 9
51P-	HYDRAULIC HOSE ENDS 3000 SERIES FLANGE	C 10
51P-	HYDRAULIC HOSE ENDS 6000 SERIES FLANGE	C 11
51P-	HYDRAULIC HOSE ENDS BLANKS & JOINERS	C 12
51P-	HYDRAULIC HOSE ENDS PUSH - ON NPT & BSPP & JIC	C 13
54P-	HYDRAULIC ADAPTORS BSP & NPT	D 1 - D 14
54P-	HYDRAULIC ADAPTORS JIC	D 15 - D 25
54P-	HYDRAULIC ADAPTORS ORFS	D 26 - D 30
54P-	HYDRAULIC ADAPTORS SAE O	D 31
54P-	HYDRAULIC ADAPTORS FLANGES SPLIT & SOLID	D 32
54P-	HYDRAULIC ADAPTORS WELDABLE & BANJO	D 33
54P-	HYDRAULIC DOWTY BONDED WASHERS & TEST POINTS	D 34
55P-	HYDRAULIC QUICK COUPLERS & BALL VALVES & PLUGS	E 1 - E6
63H-	LOW PRESSURE BALL VALVES	E 2
56P-	HYDRAULIC HOSE MACHINES	F 1 - F 2
57P-	HYDRAULIC STEEL TUBE FITTINGS	G 1 - G 19

DISCLAIMER MESSAGE:

PLEASE NOTE: ALL O.E.M. NAMES OR NUMBERS ARE FOR REFERENCE USE ONLY, HIRSCH HYDRAULICS CANNOT BE HELD RESPONSIBLE FOR THE USE OF ANY OF THE INFORMATION

DISCLOSED IN THIS CATALOGUE. THIS INFORMATION IS USED AT THE READERS DISCRETION. MANUFACTURERS NAMES, PART NUMBERS AND DESCRIPTIONS ARE FOR REFERENCE

PURPOSES ONLY. THIS DOES NOT IMPLY THAT ANY PARTS LISTED IS THE PRODUCT OF THESE MANUFACTURERS.

"PRICES AND PRODUCT AVAILABILITY ARE SUBJECT TO CHANGE WITHOUT NOTICE."

HYDRAULIC HOSES

Retail

Prices

ONE WIRE BRAID HOSE 1 SN THIN COVER

01-10-2022

EN 853 1SN THIN COVER EXCEEDS SAE 100 R1AT SHORT FERRULE SPECS

Part No	Description	Ferrule	Final Crimp	W.P. Bar	Dash	Size	Visual	Retail	
53P-1SN04	SAE 100 R1-04	52-P03310-04		225	-04	1/4"			
53P-1SN06	SAE 100 R1-06	52-P03310-06		180	-06	3/8"			
53P-1SN08	SAE 100 R1-08	52-P03310-08		160	-08	1/2"			
53P-1SN10	SAE 100 R1-10	52-P03310-10		130	-10	5/8"			
53P-1SN12	SAE 100 R1-12	52-P03310-12		105	-12	3/4"			
53P-1SN16	SAE 100 R1-16	52-P03310-16		88	-16	1"			
53P-1SN20	SAE 100 R1-20	52-P03310-20		63	-20	1 1/4"			
53P-1SN24	SAE 100 R1-24	52-P03310-24		50	-24	1 1/2"			
53P-1SN32	SAE 100 R1-32	52-P03310-32		40	-32	2"			

TWO WIRE BRAID HOSE 2 SN THIN COVER

EN 853 2SN THIN COVER EXCEEDS SAE 100 R2AT SHORT FERRULE SPECS

Part No	Description	Ferrule	Final Crimp	W.P. Bar	Dash	Size	Visual	Retail	
53P-2SN04	SAE 100 R2AT-04	52-P03310-04		400	-04	1/4"			
53P-2SN06	SAE 100 R2AT-06	52-P03310-06		330	-06	3/8"			
53P-2SN08	SAE 100 R2AT-08	52-P03310-08		275	-08	1/2"			
53P-2SN10	SAE 100 R2AT-10	52-P03310-10		250	-10	5/8"			
53P-2SN12	SAE 100 R2AT-12	52-P03310-12		215	-12	3/4"			
53P-2SN16	SAE 100 R2AT-16	52-P03310-16		165	-16	1"			
53P-2SN20	SAE 100 R2AT-20	52-P03310-20		125	-20	1 1/4"			
53P-2SN24	SAE 100 R2AT-24	52-P03310-24		90	-24	1 1/2"			
53P-2SN32	SAE 100 R2AT-32	52-P03310-32		80	-32	2"			

ONE WIRE BRAID - TEXTILE HOSE R5 COTTON COVER BLACK

SAE 100 R5 COTTON COVER BLACK REUSEABLE FERRULE SPECS

Part No	Description	Ferrule	Final Crimp	W.P. Bar	Dash	Size	Visual	Retail	
53P-R504	R5-04	52-P00518-04		210	-04	1/4"			
53P-R505	R5-05	52-P00518-05		210	-05	5/16"			
53P-R506	R5-06	52-P00518-06		155	-06	3/8"			
53P-R508	R5-08	52-P00518-08		140	-08	1/2"			
53P-R510	R5-10	52-P00518-10		120	-10	5/8"			
53P-R512	R5-12	52-P00518-12		103	-12	3/4"			
53P-R516	R5-16	52-P00518-16		55	-16	1"			
53P-R520	R5-20	52-P00518-20		45	-20	1 1/4"			
53P-R524	R5-24	52-P00518-24		35	-24	1 1/2"			
53P-R532	R5-32	52-P00518-32		25	-32	2"			

HYDRAULIC HOSES

Retail

Prices

FOUR WIRE SPIRAL HOSE 4 SP

01-10-2022

EN 856 4 SP 4 SPIRAL HOSE SHORT FERRULE SPECS

Part No	Description	Ferrule	Final Crimp	W.P. Bar	Dash	Size	Visual	Retail
53P-4SP06	EN 856 - 4SP-06	P00402-06		445	-06	3/8"		
53P-4SP08	EN 856 - 4SP-08	P00402-08		415	-08	1/2"		
53P-4SP10	EN 856 - 4SP-10	P00402-10		350	-10	5/8"		
53P-4SP12	EN 856 - 4SP-12	P00402-12		350	-12	3/4"		
53P-4SP16	EN 856 - 4SP-16	P00402-16		280	-16	1"		
53P-4SP20	EN 856 - 4SP-20	P00402-20		210	-20	1 1/4"		
53P-4SP24	EN 856 - 4SP-24	P00402-24		185	-24	1 1/2"		
53P-4SP32	EN 856 - 4SP-32	P00402-32		165	-32	2"		

FOUR WIRE SPIRAL HOSE 4 SP

EN 856 4 SP 4 SPIRAL HOSE LONG FERRULE SPECS

Part No	Description	Ferrule	Final Crimp	W.P. Bar	Dash	Size	Visual	Retail
53P-4SP06	EN 856 - 4SP-06	P00400-06		445	-06	3/8"		
53P-4SP08	EN 856 - 4SP-08	P00400-08		415	-08	1/2"		
53P-4SP10	EN 856 - 4SP-10	P00400-10		350	-10	5/8"		
53P-4SP12	EN 856 - 4SP-12	P00400-12		350	-12	3/4"		
53P-4SP16	EN 856 - 4SP-16	P00400-16		280	-16	1"		
53P-4SP20	EN 856 - 4SP-20	P00400-20		210	-20	1 1/4"		
53P-4SP24	EN 856 - 4SP-24	P00400-24		185	-24	1 1/2"		
53P-4SP32	EN 856 - 4SP-32	P00400-32		165	-32	2"		

FOUR WIRE SPIRAL HOSE 4 SH

EN 856 4 SH 4 SPIRAL HOSE LONG FERRULE SPECS

Part No	Description	Ferrule	Final Crimp	W.P. Bar	Dash	Size	Visual	Retail
53P-4SH12	EN 856 - 4SH-12	P00400-12		420	-12	3/4"		
53P-4SH16	EN 856 - 4SH-16	P00400-16		380	-16	1"		
53P-4SH20	EN 856 - 4SH-20	P00400-20		325	-20	1 1/4"		
53P-4SH24	EN 856 - 4SH-24	P00400-24		290	-24	1 1/2"		
53P-4SH32	EN 856 - 4SH-32	P00400-32		250	-32	2"		

HYDRAULIC HOSES

Retail

Prices

THERMO PLASTIC SAE 100 R7

01-10-2022

Part No	Description	Ferrule	Final Crimp	W.P. Bar	Dash	Size	Visual	Retail
53P-R704	SAE 100 R7-04	P00018-04		190	-04	¼"		
53P-R706	SAE 100 R7-06	P00018-06		155	-06	⅜"		
53P-R708	SAE 100 R7-08	P00018-08		138	-08	½"		
53P-R712	SAE 100 R7-12	P00018-12		85	-12	¾"		
53P-R716	SAE 100 R7-16	P00018-16		70	-16	1"		

TEXTILE REINFORCED HOSE (PUSH - LOCK TYPE) R6

Part No	Description	Ferrule	Final Crimp	W.P. Bar	Dash	Size	Visual	Retail
53P-R604	SAE 100 R6-04			28	-04	¼"		
53P-R606	SAE 100 R6-06			28	-06	⅜"		
53P-R608	SAE 100 R6-08			28	-08	½"		
53P-R610	SAE 100 R6-10			28	-10	⅝"		
53P-R612	SAE 100 R6-12			25	-12	¾"		

FUEL / OIL SUCTION & DELIVERY HOSE R4

Part No	Description	Ferrule	Final Crimp	W.P. Bar	Dash	Size	Visual	Retail
53P-T605-12	FOSD-12			20	-12	¾"		
53P-T605-16	FOSD-16			17	-16	1"		
53P-T605-20	FOSD-20			14	-20	1¼"		
53P-T605-24	FOSD-24			7	-24	1½"		
53P-T605-32	FOSD-32			4	-32	2"		
53P-T605-40	FOSD-40			4	-40	2½"		
53P-T605-48	FOSD-48			3	-48	3"		
53P-T605-64	FOSD-64			2	-56	3½"		

HYDRAULIC HOSE GUARD

Retail

Prices

PVC SPIRAL GUARD (PRICE PER METRE)

01-10-2022

Part No	Description	O/D	ID	1 wire	2 wire	4 spiral	Visual	Retail	
53P-SGX12	SGX12	12	9,6	-03					
53P-SGX16	SGX16	16	13,4	1/4 ,3/8	1/4,5/16				
53P-SGX20	SGX20	20	16	3/8 ,1/2	3/8,1/2	3/8			
53P-SGX25	SGX25	25	20.6	5/8 ,3/4	1/2,5/8	1/2			
53P-SGX32	SGX32	32	27	3/4 ,1"	3/4,1"	5/8,3/4,1"			
53P-SGX40	SGX40	40	34.6	1"	1"	1"			
53P-SGX50	SGX50	50	43.2	1 1/4 , 11/2	1 1/4,11/2	1 1/4			
53P-SGX63	SGX63	63	55.6	1 1/2		1 1/2			
53P-SGX75	SGX75	75	66.2	2"	2"	2"			
53P-SGX90	SGX90	90	80.2						

COIL SPRING GUARD (PRICE PER METRE)

Part No	Description	Hose Type	Suitable for	Visual	Retail
53P-CS04	CS04	R1-04	1 wire 1/4" thin cover hose		
		R2-04	2 wire 1/4" thin cover hose		
53P-CS06	CS06	R1-06	1 wire 3/8" thin cover hose		
		R2-06	2 wire 3/8" thin cover hose		
53P-CS08	CS08	R1-08	1 wire 1/2" thin cover hose		
		R1-10	1 wire 5/8" thin cover hose		
		R2-08	2 wire 1/2" thin cover hose		
53P-CS10	CS10	R2-10	2 wire 5/8" thin cover hose		
		XT3-08	Multispiral 4 wire 1/2" hose		
53P-CS12	CS12	R1-12	1 wire 3/4" thin cover hose		
		R2-12	2 wire 3/4" thin cover hose		
		XT3-12	Multispiral 4 wire 3/4" hose		
53P-CS16	CS16	R2-16	2 wire 1" thin cover hose		
		XT3-16	Multispiral 4 wire 1" hose		
53P-CS20	CS20	R1-24	1 wire 1 1/4" thin cover hose		
		R2-20	2 wire 1 1/4" thin cover hose		
		XT3-20	Multispiral 4 wire 1 1/4" hose		
53P-CS24	CS24	R2-24	2 wire 1 1/2" thin cover hose		
		XT3-24	Multispiral 4 wire 1 1/2" hose		
53P-CS32	CS32	R2-32	2 wire 2" thin cover hose		
		XT3-32	Multispiral 4 wire 2" hose		

HOSE FERRULES

Retail

Prices

ONE WIRE NON SKIVE FERRULES

01-10-2022

FERRULES FOR HOSE SAE100R1 AT AND EN853 1SN

Part No	Description	Dash	Size	Visual	Retail
52P-03310-04	1 WIRE NON SKIVE-04 CTCL1-04	-04	1/4		
52P-03310-05	1 WIRE NON SKIVE-05 CTCL1-05	-05	5/16		
52P-03310-06	1 WIRE NON SKIVE-06 CTCL1-06	-06	3/8		
52P-03310-08	1 WIRE NON SKIVE-08 CTCL1-08	-08	1/2		
52P-03310-10	1 WIRE NON SKIVE-10 CTCL1-10	-10	5/8		
52P-03310-12	1 WIRE NON SKIVE-12 CTCL1-12	-12	3/4		
52P-03310-16	1 WIRE NON SKIVE-16 CTCL1-16	-16	1		
52P-03310-20	1 WIRE NON SKIVE-20 CTCL1-20	-20	1 1/4		
52P-03310-24	1 WIRE NON SKIVE-24 CTCL1-24	-24	1 1/2		
52P-03310-32	1 WIRE NON SKIVE-32 CTCL1-32	-32	2		

TWO WIRE NON SKIVE FERRULES

FERRULES FOR HOSE SAE100R2 AT AND EN853 2SN

Part No	Description	Dash	Size	Visual	Retail
52P-03310-04	2 WIRE NON SKIVE-04 XTCL-04	-04	1/4		
52P-03310-05	2 WIRE NON SKIVE-05 XTCL-05	-05	5/16		
52P-03310-06	2 WIRE NON SKIVE-06 XTCL-06	-06	3/8		
52P-03310-08	2 WIRE NON SKIVE-08 XTCL-08	-08	1/2		
52P-03310-10	2 WIRE NON SKIVE-10 XTCL-10	-10	5/8		
52P-03310-12	2 WIRE NON SKIVE-12 XTCL-12	-12	3/4		
52P-03310-16	2 WIRE NON SKIVE-16 XTCL-16	-16	1		
52P-03310-20	2 WIRE NON SKIVE-20 XTCL-20	-20	1 1/4		
52P-03310-24	2 WIRE NON SKIVE-24 XTCL-24	-24	1 1/2		
52P-03310-32	2 WIRE NON SKIVE-32 XTCL-32	-32	2		

TWO WIRE SKIVE FERRULES

FERRULES FOR HOSE SAE100R2 AT AND EN853 2SN

Part No	Description	Dash	Size	Visual	Retail
52P-00200-04	2 WIRE SKIVE-04 CX04BD	-04	1/4		
52P-00200-05	2 WIRE SKIVE-05 CX05BD	-05	5/16		
52P-00200-06	2 WIRE SKIVE-06 CX06BD	-06	3/8		
52P-00200-08	2 WIRE SKIVE-08 CX08BD	-08	1/2		
52P-00200-10	2 WIRE SKIVE-10 CX10BD	-10	5/8		
52P-00200-12	2 WIRE SKIVE-12 CX12BD	-12	3/4		
52P-00200-16	2 WIRE SKIVE-16 CX16BD	-16	1		
52P-00200-20	2 WIRE SKIVE-20 CX20BD	-20	1 1/4		
52P-00200-24	2 WIRE SKIVE-24 CX24BD	-24	1 1/2		
52P-00200-32	2 WIRE SKIVE-32 CX32BD	-32	2		

HOSE FERRULES

Retail

Prices

FOUR SPIRAL SKIVE SHORT FERRULES

01-10-2022

SHORT FERRULES FOR HOSE R12 / 4SP / 4SH

Part No	Description	Dash	Size	Visual	Retail
52P-00402-06	4 SPIRAL SKIVE-06 H06FLW	-06	3/8		
52P-00402-08	4 SPIRAL SKIVE-08 H08FLW	-08	1/2		
52P-00402-10	4 SPIRAL SKIVE-10 H10FLW	-10	5/8		
52P-00402-12	4 SPIRAL SKIVE-12 H12FLW	-12	3/4		
52P-00402-16	4 SPIRAL SKIVE-16 H16FLW	-16	1		
52P-00402-20	4 SPIRAL SKIVE-20 H20FLW	-20	1 1/4		
52P-00402-24	4 SPIRAL SKIVE-24 H24FLW	-24	1 1/2		
52P-00402-32	4 SPIRAL SKIVE-32 H32FLW	-32	2		
	ONLY TO BE USE WTH HOSE TAIL XXXX1-XX-XX				

FOUR SPIRAL SKIVE LONG FERRULES

LONG FERRULES FOR HOSE R12 / 4SP / 4SH

Part No	Description	Dash	Size	Visual	Retail
52P-00400-06	4 SPIRAL SKIVE-06	-06	3/8		
52P-00400-08	4 SPIRAL SKIVE-08	-08	1/2		
52P-00400-10	4 SPIRAL SKIVE-10	-10	5/8		
52P-00400-12	4 SPIRAL SKIVE-12	-12	3/4		
52P-00400-16	4 SPIRAL SKIVE-16	-16	1		
52P-00400-20	4 SPIRAL SKIVE-20	-20	1 1/4		
52P-00400-24	4 SPIRAL SKIVE-24	-24	1 1/2		
52P-00400-32	4 SPIRAL SKIVE-32	-32	2		
	ONLY TO BE USE WTH HOSE TAIL XXXX2-XX-XX				

2 POLYESTER BRAID FERRULES FOR HOSE SAE100 R7 / EN855 R7

Part No	Description	Dash	Size	Visual	Retail
52P-00018-03	2 POLYESTER R7-03 3381-03	-03	3/16		
52P-00018-04	2 POLYESTER R7-04 3381-04	-04	1/4		
52P-00018-05	2 POLYESTER R7-05 3381-05	-05	5/16		
52P-00018-06	2 POLYESTER R7-06 3381-06	-06	3/8		
52P-00018-08	2 POLYESTER R7-08 3381-08	-08	1/2		
52P-00018-10	2 POLYESTER R7-10 3381-10	-10	5/8		
52P-00018-12	2 POLYESTER R7-12 3381-12	-12	3/4		
52P-00018-16	2 POLYESTER R7-16 3381-16	-16	1		

BOLT CLAMP FOR SUCTION HOSE

Part No	Description	Dash	Size	Visual	Retail
52P-B16-T605	BOLT CLAMP FOR SUCTION HOSE 1"	-16	1		
52P-B20-T605	BOLT CLAMP FOR SUCTION HOSE 1 1/4"	-20	1 1/4		
52P-B24-T605	BOLT CLAMP FOR SUCTION HOSE 1 1/2"	-24	1 1/2		
52P-B32-T605	BOLT CLAMP FOR SUCTION HOSE 2"	-32	2		

B.S.P. HOSE END

HOSE ENDS ARE SUITABLE FOR 1 - WIRE, 2 - WIRE & 4 - SPIRAL HOSES

Retail

Prices

BSP HOSE END - STRAIGHT FEMALE

19-07-2023

Part No	Description	BSP	Hose	Visual	Retail
51P-22611-02-04	BSPF-02-04 X02BF04	1/8"	1/4"		
51P-22611-04-04	BSPF-04-04 X04BF04	1/4"	1/4"		
51P-22611-04-06	BSPF-04-06 X04BF06	1/4"	3/8"		
51P-22611-06-04	BSPF-06-04 X06BF04	3/8"	1/4"		
51P-22611-06-06	BSPF-06-06 X06BF06	3/8"	3/8"		
51P-22611-06-08	BSPF-06-08 X06BF08	3/8"	1/2"		
51P-22611-08-06	BSPF-08-06 X08BF06	1/2"	3/8"		
51P-22611-08-08	BSPF-08-08 X08BF08	1/2"	1/2"		
51P-22611-08-10	BSPF-08-10 X08BF10	1/2"	5/8"		
51P-22611-08-12	BSPF-08-12 X08BF12	1/2"	3/4"		
51P-22611-10-08	BSPF-10-08 X10BF08	5/8"	1/2"		
51P-22611-10-10	BSPF-10-10 X10BF10	5/8"	5/8"		
51P-22611-12-08	BSPF-12-08 X12BF08	3/4"	1/2"		
51P-22611-12-10	BSPF-12-10 X12BF10	3/4"	5/8"		
51P-22611-12-12	BSPF-12-12 X12BF12	3/4"	3/4"		
51P-22611-12-16	BSPF-12-16 X12BF16	3/4"	1"		
51P-22611-16-12	BSPF-16-12 X16BF12	1"	3/4"		
51P-22611-16-16	BSPF-16-16 X16BF16	1"	1"		
51P-22611-20-16	BSPF-20-16 X20BF16	1 1/4"	1"		
51P-22611-20-20	BSPF-20-20 X20BF20	1 1/4"	1 1/4"		
51P-22611-24-24	BSPF-24-24 X24BF24	1 1/2"	1 1/2"		
51P-22611-32-32	BSPF-32-32 X32BF32	2"	2"		

BSP HOSE END - 45°

Part No	Description	BSP	Hose	Visual	Retail
51P-22641-04-04	BSPF45-04-04 X04B45S04	1/4"	1/4"		
51P-22641-06-06	BSPF45-06-06 X06B45S06	3/8"	3/8"		
51P-22641-08-08	BSPF45-08-08 X08B45S08	1/2"	1/2"		
51P-22641-10-08	BSPF45-10-08 X10B45S08	5/8"	1/2"		
51P-22641-10-10	BSPF45-10-10 X10B45S10	5/8"	5/8"		
51P-22641-12-10	BSPF45-12-10 X12B45S10	3/4"	5/8"		
51P-22641-12-12	BSPF45-12-12 X12B45S12	3/4"	3/4"		
51P-22641-16-16	BSPF45-16-16 X16B45S16	1"	1"		
51P-22641-20-20	BSPF45-20-20 X20B45S20	1 1/4"	1 1/4"		
51P-22641-24-24	BSPF45-24-24 X24B45S24	1 1/2"	1 1/2"		
51P-22641-32-32	BSPF45-32-32 X32B45S32	2"	2"		

BSP HOSE END - 90°

Part No	Description	BSP	Hose	Visual	Retail
51P-22691-02-04	BSPF90-02-04 X02B90S04	1/8"	1/4"		
51P-22691-04-04	BSPF90-04-04 X04B90S04	1/4"	1/4"		
51P-22691-06-04	BSPF90-06-04 X06B90S04	3/8"	1/4"		
51P-22691-06-06	BSPF90-06-06 X06B90S06	3/8"	3/8"		
51P-22691-08-06	BSPF90-08-06 X08B90S06	1/2"	3/8"		
51P-22691-08-08	BSPF90-08-08 X08B90S08	1/2"	1/2"		
51P-22691-10-08	BSPF90-10-08 X10B90S08	5/8"	1/2"		
51P-22691-10-10	BSPF90-10-10 X10B90S10	5/8"	5/8"		
51P-22691-12-08	BSPF90-12-08 X12B90S08	3/4"	1/2"		
51P-22691-12-10	BSPF90-12-10 X12B90S10	3/4"	5/8"		
51P-22691-12-12	BSPF90-12-12 X12B90S12	3/4"	3/4"		
51P-22691-16-12	BSPF90-16-12 X16B90S12	1"	3/4"		
51P-22691-16-16	BSPF90-16-16 X16B90S16	1"	1"		
51P-22691-20-16	BSPF90-20-16 X20B90S16	1 1/4"	1"		
51P-22691-20-20	BSPF90-20-20 X20B90S20	1 1/4"	1 1/4"		
51P-22691-24-24	BSPF90-24-24 X24B90S24	1 1/2"	1 1/2"		
51P-22691-32-32	BSPF90-32-32 X32B90S32	2"	2"		

B.S.P & N.P.T HOSE END

HOSE ENDS ARE SUITABLE FOR 1 - WIRE, 2 - WIRE & 4 - SPIRAL HOSES

Retail

Prices

BSP HOSE END - MALE

19-07-2023

Part No	Description	BSP	Hose	Visual	Retail
51P-12611A0204	BSPM-02-04 X02BM04	1/8"	1/4"		
51P-12611A0404	BSPM-04-04 X04BM04	1/4"	1/4"		
51P-12611A0604	BSPM-06-04 X06BM04	3/8"	1/4"		
51P-12611A0606	BSPM-06-06 X06BM06	3/8"	3/8"		
51P-12611A0806	BSPM-08-06 X08BM06	1/2"	3/8"		
51P-12611A0808	BSPM-08-08 X08BM08	1/2"	1/2"		
51P-12611A1008	BSPM-10-08 X10BM08	5/8"	1/2"		
51P-12611A1010	BSPM-10-10 X10BM10	5/8"	5/8"		
51P-12611A1212	BSPM-12-12 X12BM12	3/4"	3/4"		
51P-12611A1612	BSPM-16-12 X16BM12	1"	3/4"		
51P-12611A1616	BSPM-16-16 X16BM16	1"	1"		
51P-12611A2020	BSPM-20-20 X20BM20	1 1/4"	1 1/4"		
51P-12611A2424	BSPM-24-24 X24BM24	1 1/2"	1 1/2"		
51P-12611A3232	BSPM-32-32 X32BM32	2"	2"		

BSP COMPACT ELBOW

Part No	Description	BSP	Hose	Visual	Retail
51P-22691K0606	BSPFCOMP-06-06 X06B9006K	3/8"	3/8"		
51P-22691K0808	BSPFCOMP-08-08 X08B9008K	1/2"	1/2"		

BSP FLAT FACE

Part No	Description	BSP	Hose	Visual	Retail
51P-22211-06-06	BSPFF-06-06 X06FF06	3/8"	3/8"		
51P-22211-08-06	BSPFF-08-06 X08FF06	1/2"	3/8"		
51P-22211-08-08	BSPFF-08-08 X08FF08	1/2"	1/2"		
51P-22211-12-08	BSPFF-12-08 X12FF08	3/4"	1/2"		
51P-22211-12-10	BSPFF-12-10 X12FF10	3/4"	5/8"		
51P-22211-12-12	BSPFF-12-12 X12FF12	3/4"	3/4"		
51P-22211-16-16	BSPFF-16-16 X16FF16	1"	1"		

NPT MALE

Part No	Description	Npt	Hose	Visual	Retail
51P-15611-02-03	NPT-02-03 X02NM03	1/8"	3/16"		
51P-15611-02-04	NPT-02-04 X02NM04	1/8"	1/4"		
51P-15611-04-04	NPT-04-04 X04NM04	1/4"	1/4"		
51P-15611-04-06	NPT-04-06 X04NM06	1/4"	3/8"		
51P-15611-06-04	NPT-06-04 X06NM04	3/8"	1/4"		
51P-15611-06-06	NPT-06-06 X06NM06	3/8"	3/8"		
51P-15611-06-08	NPT-06-08 X06NM08	3/8"	1/2"		
51P-15611-08-06	NPT-08-06 X08NM06	1/2"	3/8"		
51P-15611-08-08	NPT-08-08 X08NM08	1/2"	1/2"		
51P-15611-08-10	NPT-08-10 X08NM10	1/2"	5/8"		
51P-15611-08-12	NPT-08-12 X08NM12	1/2"	3/4"		
51P-15611-12-08	NPT-12-08 X12NM08	3/4"	1/2"		
51P-15611-12-10	NPT-12-10 X12NM10	3/4"	5/8"		
51P-15611-12-12	NPT-12-12 X12NM12	3/4"	3/4"		
51P-15611-12-16	NPT-12-16 X12NM16	3/4"	1"		
51P-15611-16-12	NPT-16-12 X16NM12	1"	3/4"		
51P-15611-16-16	NPT-16-16 X16NM16	1"	1"		
51P-15611-20-20	NPT-20-20 X20NM20	1 1/4"	1 1/4"		
51P-15611-24-24	NPT-24-24 X24NM24	1 1/2"	1 1/2"		
51P-15611-32-32	NPT-32-32 X32NM32	2"	2"		

J.I.C. SAE HOSE END

HOSE ENDS ARE SUITABLE FOR 1 - WIRE, 2 - WIRE & 4 - SPIRAL HOSES

Retail

Prices

JIC FEMALE STRAIGHT

19-07-2023

Part No	Description	Jic	Hose	Visual	Retail
51P-26711-04-04	JICF-04-04 X07JF04	-04	1/4"		
51P-26711-05-04	JICF-05-04 X08JF04	-05	1/4"		
51P-26711-06-04	JICF-06-04 X09JF04	-06	1/4"		
51P-26711-06-06	JICF-06-06 X09JF06	-06	3/8"		
51P-26711-07-06	JICF-07-06 X10JF06	-07	3/8"		
51P-26711-08-06	JICF-08-06 X12JF06	-08	3/8"		
51P-26711-08-08	JICF-08-08 X12JF08	-08	1/2"		
51P-26711-10-08	JICF-10-08 X14JF08	-10	1/2"		
51P-26711-10-10	JICF-10-10 X14JF10	-10	5/8"		
51P-26711-10-12	JICF-10-12 X14JF12	-10	3/4"		
51P-26711-12-08	JICF-12-08 X17JF08	-12	1/2"		
51P-26711-12-10	JICF-12-10 X17JF10	-12	5/8"		
51P-26711-12-12	JICF-12-12 X17JF12	-12	3/4"		
51P-26711-12-16	JICF-12-16 X17JF16	-12	1"		
51P-26711-14-12	JICF-14-12 X19JF12	-14	3/4"		
51P-26711-16-12	JICF-16-12 X21JF12	-16	3/4"		
51P-26711-16-16	JICF-16-16 X21JF16	-16	1"		
51P-26711-20-16	JICF-20-16 X26JF16	-20	1"		
51P-26711-20-20	JICF-20-20 X26JF20	-20	1 1/4"		
51P-26711-24-24	JICF-24-24 X30JF24	-24	1 1/2"		
51P-26711-32-32	JICF-32-32 X40JF32	-32	2"		

JIC FEMALE 45°

Part No	Description	Jic	Hose	Visual	Retail
51P-26741-04-04	JICF45-04-04 X07J45S04	-04	1/4"		
51P-26741-05-04	JICF45-05-04 X08J45S04	-05	1/4"		
51P-26741-06-04	JICF45-06-04 X09J45S04	-06	1/4"		
51P-26741-06-06	JICF45-06-06 X09J45S06	-06	3/8"		
51P-26741-08-06	JICF45-08-06 X12J45S06	-08	3/8"		
51P-26741-08-08	JICF45-08-08 X12J45S08	-08	1/2"		
51P-26741-10-08	JICF45-10-08 X14J45S08	-10	1/2"		
51P-26741-10-10	JICF45-10-10 X14J45S10	-10	5/8"		
51P-26741-12-08	JICF45-12-08 X17J45S08	-12	1/2"		
51P-26741-12-10	JICF45-12-10 X17J45S10	-12	5/8"		
51P-26741-12-12	JICF45-12-12 X17J45S12	-12	3/4"		
51P-26741-14-12	JICF45-14-12 X19J45S12	-14	3/4"		
51P-26741-16-12	JICF45-16-12 X21J45S12	-16	3/4"		
51P-26741-16-16	JICF45-16-16 X21J45S16	-16	1"		
51P-26741-20-20	JICF45-20-20 X26J45S20	-20	1 1/4"		
51P-26741-24-24	JICF45-24-24 X30J45S24	-24	1 1/2"		
51P-26741-32-32	JICF45-32-32 X40J45S32	-32	2"		

J.I.C. HOSE END

HOSE ENDS ARE SUITABLE FOR 1 - WIRE, 2 - WIRE & 4 - SPIRAL HOSES

Retail

Prices

JIC FEMALE 90°

19-07-2023

Part No	Description	Jic	Hose	Visual	Retail
51P-26791-04-04	JICF90-04-04 X07J90S04	-04	1/4"		
51P-26791-05-04	JICF90-05-04 X08J90S04	-05	1/4"		
51P-26791-06-04	JICF90-06-04 X09J90S04	-06	1/4"		
51P-26791-06-06	JICF90-06-06 X09J90S06	-06	3/8"		
51P-26791-07-06	JICF90-07-06 X10J90S06	-07	3/8"		
51P-26791-08-06	JICF90-08-06 X12J90S06	-08	3/8"		
51P-26791-08-08	JICF90-08-08 X12J90S08	-08	1/2"		
51P-26791-10-08	JICF90-10-08 X14J90S08	-10	1/2"		
51P-26791-10-10	JICF90-10-10 X14J90S10	-10	5/8"		
51P-26791-12-08	JICF90-12-08 X17J90S08	-12	1/2"		
51P-26791-12-10	JICF90-12-10 X17J90S10	-12	5/8"		
51P-26791-12-12	JICF90-12-12 X17J90S12	-12	3/4"		
51P-26791-14-12	JICF90-14-12 X19J90S12	-14	3/4"		
51P-26791-16-12	JICF90-16-12 X21J90S12	-16	3/4"		
51P-26791-16-16	JICF90-16-16 X21J90S16	-16	1"		
51P-26791-20-20	JICF90-20-20 X26J90S20	-20	1 1/4"		
51P-26791-24-24	JICF90-24-24 X30J90S24	-24	1 1/2"		
51P-26791-32-32	JICF90-32-32 X40J90S32	-32	2"		

JIC MALE STRAIGHT

Part No	Description	Jic	Hose	Visual	Retail
51P-16711-04-04	JICM-04-04 X07JM04	-04	1/4"		
51P-16711-05-04	JICM-05-04 X08JM04	-05	1/4"		
51P-16711-06-04	JICM-06-04 X09JM04	-06	1/4"		
51P-16711-06-05	JICM-06-05 X09JM05	-06	5/16"		
51P-16711-06-06	JICM-06-06 X09JM06	-06	3/8"		
51P-16711-07-06	JICM-07-06 X10JM06	-07	3/8"		
51P-16711-08-06	JICM-08-06 X12JM06	-08	3/8"		
51P-16711-08-08	JICM-08-08 X12JM08	-08	1/2"		
51P-16711-10-08	JICM-10-08 X14JM08	-10	1/2"		
51P-16711-10-10	JICM-10-10 X14JM10	-10	5/8"		
51P-16711-12-08	JICM-12-08 X17JM08	-12	1/2"		
51P-16711-12-10	JICM-12-10 X17JM10	-12	5/8"		
51P-16711-12-12	JICM-12-12 X17JM12	-12	3/4"		
51P-16711-14-12	JICM-14-12 X19JM12	-14	3/4"		
51P-16711-16-12	JICM-16-12 X21JM12	-16	3/4"		
51P-16711-16-16	JICM-16-16 X21JM16	-16	1"		
51P-16711-20-20	JICM-20-20 X26JM20	-20	1 1/4"		
51P-16711-24-24	JICM-24-24 X30JM24	-24	1 1/2"		
51P-16711-32-32	JICM-32-32 X40JM32	-32	2"		

METRIC STAND PIPE HOSE END

HOSE ENDS ARE SUITABLE FOR 1 - WIRE, 2 - WIRE & 4 - SPIRAL HOSES

Retail

Prices

STAND PIPES - STRAIGHT

19-07-2023

Part No	Description	Tube OD	Hose	Visual	Retail
51P-50011-06-04	METSP-06-04 X06MOSE04	6mm	1/4"		
51P-50011-08-04	METSP-08-04 X08MOSE04	8mm	1/4"		
51P-50011-08-06	METSP-08-06 X08MOSE06	8mm	3/8"		
51P-50011-10-04	METSP-10-04 X10MOSE04	10mm	1/4"		
51P-50011-10-06	METSP-10-06 X10MOSE06	10mm	3/8"		
51P-50011-12-04	METSP-12-04 X12MOSE04	12mm	1/4"		
51P-50011-12-06	METSP-12-06 X12MOSE06	12mm	3/8"		
51P-50011-12-08	METSP-12-08 X12MOSE08	12mm	1/2"		
51P-50011-14-06	METSP-14-06 X14MOSE06	14mm	3/8"		
51P-50011-14-08	METSP-14-08 X14MOSE08	14mm	1/2"		
51P-50011-15-06	METSP-15-06 X15MOSE06	15mm	3/8"		
51P-50011-15-08	METSP-15-08 X15MOSE08	15mm	1/2"		
51P-50011-16-08	METSP-16-08 X16MOSE08	16mm	1/2"		
51P-50011-18-08	METSP-18-08 X18MOSE08	18mm	1/2"		
51P-50011-18-10	METSP-18-10 X18MOSE10	18mm	5/8"		
51P-50011-18-12	METSP-18-12 X18MOSE12	18mm	3/4"		
51P-50011-20-10	METSP-20-10 X20MOSE10	20mm	5/8"		
51P-50011-20-12	METSP-20-12 X20MOSE12	20mm	3/4"		
51P-50011-22-12	METSP-22-12 X22MOSE12	22mm	3/4"		
51P-50011-22-16	METSP-22-16 X22MOSE16	22mm	1"		
51P-50011-25-12	METSP-25-12 X25MOSE12	25mm	3/4"		
51P-50011-25-16	METSP-25-16 X25MOSE16	25mm	1"		
51P-50011-28-16	METSP-28-16 X28MOSE16	28mm	1"		
51P-50011-30-16	METSP-30-16 X30MOSE16	30mm	1"		
51P-50011-35-20	METSP-35-20 X35MOSE20	35mm	1 1/4"		
51P-50011-38-24	METSP-38-24 X38MOSE24	38mm	1 1/2"		
51P-50011-42-24	METSP-42-24 X42MOSE24	42mm	1 1/2"		

STAND PIPES - 45°

Part No	Description	Tube OD	Hose	Visual	Retail
51P-50041-06-04	METSP-45-06-04 X06MOSE45S04	6mm	1/4"		
51P-50041-08-04	METSP-45-08-04 X08MOSE45S04	8mm	1/4"		
51P-50041-10-04	METSP-45-10-04 X10MOSE45S04	10mm	1/4"		
51P-50041-10-06	METSP-45-10-06 X10MOSE45S06	10mm	3/8"		
51P-50041-12-04	METSP-45-12-04 X12MOSE45S04	12mm	1/4"		
51P-50041-12-06	METSP-45-12-06 X12MOSE45S06	12mm	3/8"		
51P-50041-15-08	METSP-45-15-08 X15MOSE45S08	15mm	1/2"		
51P-50041-16-08	METSP-45-16-08 X16MOSE45S08	16mm	1/2"		
51P-50041-18-10	METSP-45-18-10 X18MOSE45S10	18mm	5/8"		
51P-50041-20-10	METSP-45-20-10 X20MOSE45S10	20mm	5/8"		
51P-50041-22-12	METSP-45-22-12 X22MOSE45S12	22mm	3/4"		
51P-50041-25-12	METSP-45-25-12 X25MOSE45S12	25mm	3/4"		
51P-50041-25-16	METSP-45-25-16 X25MOSE45S16	25mm	1"		

STAND PIPES - 90°

Part No	Description	Tube OD	Hose	Visual	Retail
51P-50091-06-04	METSP-90-06-04 X06MOSE90S04	6mm	1/4"		
51P-50091-08-04	METSP-90-08-04 X08MOSE90S04	8mm	1/4"		
51P-50091-10-04	METSP-90-10-04 X10MOSE90S04	10mm	1/4"		
51P-50091-10-06	METSP-90-10-06 X10MOSE90S06	10mm	3/8"		
51P-50091-12-04	METSP-90-12-04 X12MOSE90S04	12mm	1/4"		
51P-50091-12-06	METSP-90-12-06 X12MOSE90S06	12mm	3/8"		
51P-50091-12-08	METSP-90-12-08 X12MOSE90S08	12mm	1/2"		
51P-50091-14-06	METSP-90-14-06 X14MOSE90S06	14mm	3/8"		
51P-50091-15-08	METSP-90-15-08 X15MOSE90S08	15mm	1/2"		
51P-50091-16-08	METSP-90-16-08 X16MOSE90S08	16mm	1/2"		
51P-50091-18-08	METSP-90-18-08 X18MOSE90S08	18mm	1/2"		
51P-50091-18-10	METSP-90-18-10 X18MOSE90S10	18mm	5/8"		
51P-50091-20-10	METSP-90-20-10 X20MOSE90S10	20mm	5/8"		
51P-50091-20-12	METSP-90-20-12 X20MOSE90S12	20mm	3/4"		
51P-50091-22-12	METSP-90-22-12 X22MOSE90S12	22mm	3/4"		
51P-50091-25-12	METSP-90-25-12 X25MOSE90S12	25mm	3/4"		
51P-50091-25-16	METSP-90-25-16 X25MOSE90S16	25mm	1"		

METRIC - (LIGHT DUTY) HOSE END

HOSE ENDS ARE SUITABLE FOR 1 - WIRE, 2 - WIRE & 4 - SPIRAL HOSES

Retail

Prices

METRIC SWAGE FITTINGS - LIGHT SERIES - STR FEMALE

30-03-2023

Part No	Description	Thread	Pipe	Hose	Visual	Retail
51P-20411-12-04	METF-06L-04 X12MSF06-04L	12 x 1.5	6L	1/4		
51P-20411-14-04	METF-08L-04 X14MSF08-04L	14 x 1.5	8L	1/4		
51P-20411-16-04	METF-10L-04 X16MSF10-04L	16 x 1.5	10L	1/4		
51P-20411-16-06	METF-10L-06 X16MSF10-06L	16 x 1.5	10L	3/8		
51P-20411-18-04	METF-12L-04 X18MSF12-04L	18 x 1.5	12L	1/4		
51P-20411-18-06	METF-12L-06 X18MSF12-06L	18 x 1.5	12L	3/8		
51P-20411-22-06	METF-15L-06 X22MSF15-06L	22 x 1.5	15L	3/8		
51P-20411-22-08	METF-15L-08 X22MSF15-08L	22 x 1.5	15L	1/2		
51P-20411-26-08	METF-18L-08 X26MSF18-08L	26 x 1.5	18L	1/2		
51P-20411-26-10	METF-18L-10 X26MSF18-10L	26 x 1.5	18L	5/8		
51P-20411-30-12	METF-22L-12 X30MSF22-12L	30 x 2	22L	3/4		
51P-20411-36-16	METF-28L-16 X36MSF28-16L	36 x 2	28L	1		
51P-20411-45-20	METF-35L-20 X45MSF35-20L	45 x 2	35L	1 1/4		
51P-20411-52-24	METF-42L-24 X52MSF42-24L	52 x 2	42L	1 1/2		

METRIC SWAGE FITTINGS - LIGHT SERIES - 45°

Part No	Description	Thread	Pipe	Hose	Visual	Retail
51P-20441-12-04	METF-45-06L-04 X12MSF45S-06-04	12 x 1.5	6L	1/4		
51P-20441-14-04	METF-45-08L-04 X14MSF45S-08-04	14 x 1.5	8L	1/4		
51P-20441-16-04	METF-45-10L-04 X16MSF45S-10-04	16 x 1.5	10L	1/4		
51P-20441-16-06	METF-45-10L-06 X16MSF45S-10-06	16 x 1.5	10L	3/8		
51P-20441-18-06	METF-45-12L-06 X18MSF45S-12-06	18 x 1.5	12L	3/8		
51P-20441-22-08	METF-45-15L-08 X22MSF45S-15-08	22 x 1.5	15L	1/2		
51P-20441-26-08	METF-45-18L-08 X26MSF45S-18-08	26 x 1.5	18L	1/2		
51P-20441-26-10	METF-45-18L-10 X26MSF45S-18-10	26 x 1.5	18L	5/8		
51P-20441-30-12	METF-45-22L-12 X30MSF45S-22-12	30 x 2	22L	3/4		
51P-20441-36-16	METF-45-28L-16 X36MSF45S-28-16	36 x 2	28L	1		
51P-20441-45-20	METF-45-35L-20 X45MSF45S-35-20	45 x 2	35L	1 1/4		
51P-20441-52-24	METF-45-42L-24 X52MSF45S-42-24	52 x 2	42L	1 1/2		

METRIC SWAGE FITTINGS - LIGHT SERIES - 90°

Part No	Description	Thread	Pipe	Hose	Visual	Retail	
51P-20491-12-04	METF-90-06L-04 X12MSF90S-06-04	12 x 1.5	6L	1/4			
51P-20491-14-04	METF-90-08L-04 X14MSF90S-08-04	14 x 1.5	8L	1/4			
51P-20491-16-04	METF-90-10L-04 X16MSF90S-10-04	16 x 1.5	10L	1/4			
51P-20491-16-05	METF-90-10L-05 X16MSF90S-10-05	16 x 1.5	10L	5/16			
51P-20491-16-06	METF-90-10L-06 X16MSF90S-10-06	16 x 1.5	10L	3/8			
51P-20491-18-06	METF-90-12L-06 X18MSF90S-12-06	18 x 1.5	12L	3/8			
51P-20491-22-06	METF-90-15L-06 X22MSF90S-15-06	22 x 1.5	15L	3/8			
51P-20491-22-08	METF-90-15L-08 X22MSF90S-15-08	22 x 1.5	15L	1/2			
51P-20491-26-08	METF-90-18L-08 X26MSF90S-18-08	26 x 1.5	18L	1/2			
51P-20491-26-10	METF-90-18L-10 X26MSF90S-18-10	26 x 1.5	18L	5/8			
51P-20491-30-12	METF-90-22L-12 X30MSF90S-22-12	30 x 2	22L	3/4			
51P-20491-36-16	METF-90-28L-16 X36MSF90S-28-16	36 x 2	28L	1			
51P-20491-45-20	METF-90-35L-20 X45MSF90S-35-20	45 x 2	35L	1 1/4			
51P-20491-52-24	METF-90-42L-24 X52MSF90S-42-24	52 x 2	42L	1 1/2			

METRIC - (HEAVY DUTY) HOSE END

Retail

HOSE ENDS ARE SUITABLE FOR 1 - WIRE, 2 - WIRE & 4 - SPIRAL HOSES

Prices

METRIC SWAGE FITTINGS - HEAVY SERIES - STR FEMALE

19-07-2023

Part No	Description	Thread	Pipe	Hose	Visual	Retail
51P-20511-16-04	METF-08S-04 X16MSF08-04	16 x 1.5	8S	1/4		
51P-20511-18-04	METF-10S-04 X18MSF10-04	18 x 1.5	10S	1/4		
51P-20511-20-06	METF-12S-06 X20MSF12-06	20 x 1.5	12S	3/8		
51P-20511-22-06	METF-14S-06 X22MSF14-06	22 x 1.5	14S	3/8		
51P-20511-24-08	METF-16S-08 X24MSF16-08	24 x 1.5	16S	1/2		
51P-20511-30-10	METF-20S-10 X30MSF20-10	30 x 2.0	20S	5/8		
51P-20511-30-12	METF-20S-12 X30MSF20-12	30 x 2.0	20S	3/4		
51P-20511-36-12	METF-25S-12 X36MSF25-12	36 x 2.0	25S	3/4		
51P-20511-36-16	METF-25S-16 X36MSF25-16	36 x 2.0	25S	1		
51P-20511-42-16	METF-30S-16 X42MSF30-16	42 x 2.0	30S	1		
51P-20511-52-20	METF-38S-20 X52MSF38-20	52 x 2.0	38S	1 1/4		

METRIC SWAGE FITTINGS - HEAVY SERIES - 45°

Part No	Description	Thread	Pipe	Hose	Visual	Retail
51P-20541-16-04	METF45-08S-04 X16MSF45S-08-04	16 x 1.5	8S	1/4		
51P-20541-18-04	METF45-10S-04 X18MSF45S-10-04	18 x 1.5	10S	1/4		
51P-20541-20-06	METF45-12S-06 X20MSF45S-12-06	20 x 1.5	12S	3/8		
51P-20541-22-06	METF45-14S-06 X22MSF45S-14-06	22 x 1.5	14S	3/8		
51P-20541-24-08	METF45-16S-08 X24MSF45S-16-08	24 x 1.5	16S	1/2		
51P-20541-30-10	METF45-20S-10 X30MSF45S-20-10	30 x 2.0	20S	5/8		
51P-20541-30-12	METF45-20S-12 X30MSF45S-20-12	30 x 2.0	20S	3/4		
51P-20541-36-12	METF45-25S-12 X36MSF45S-25-12	36 x 2.0	25S	3/4		
51P-20541-36-16	METF45-25S-16 X36MSF45S-25-16	36 x 2.0	25S	1		
51P-20541-42-16	METF45-30S-16 X42MSF45S-30-16	42 x 2.0	30S	1		
51P-20541-52-20	METF45-38S-20 X52MSF45S-38-20	52 x 2.0	38S	1 1/4		

METRIC SWAGE FITTINGS - HEAVY SERIES - 90°

Part No	Description	Thread	Pipe	Hose	Visual	Retail	
51P-20591-16-04	MET90-F08S-04 X16MSF90S-08-04	16 x 1.5	8S	1/4			
51P-20591-18-04	MET90-F10S-04 X18MSF90S-10-04	18 x 1.5	10S	1/4			
51P-20591-20-06	MET90-F12S-06 X20MSF90S-12-06	20 x 1.5	12S	3/8			
51P-20591-22-06	MET90-F14S-06 X22MSF90S-14-06	22 x 1.5	14S	3/8			
51P-20591-24-08	MET90-F16S-08 X24MSF90S-16-08	24 x 1.5	16S	1/2			
51P-20591-30-10	MET90-F20S-10 X30MSF90S-20-10	30 x 2.0	20S	5/8			
51P-20591-30-12	MET90-F20S-12 X30MSF90S-20-12	30 x 2.0	20S	3/4			
51P-20591-36-12	MET90-F25S-12 X36MSF90S-25-12	36 x 2.0	25S	3/4			
51P-20591-36-16	MET90-F25S-16 X36MSF90S-25-16	36 x 2.0	25S	1			
51P-20591-42-16	MET90-F30S-16 X42MSF90S-30-16	42 x 2.0	30S	1			
51P-20591-52-20	MET90-F38S-20 X52MSF90S-38-20	52 x 2.0	38S	1 1/4			

METRIC MALE HOSE END

HOSE ENDS ARE SUITABLE FOR 1 - WIRE, 2 - WIRE & 4 - SPIRAL HOSES

METRIC SWAGE FITTINGS - LIGHT SERIES - STR MALE

Part No	Description	Thread	Pipe	Hose	Visual	Retail
51P-10411-12-04	METM-06L-04 X12ME06-04	12 x 1.5	6L	1/4		
51P-10411-14-04	METM-08L-04 X14ME08-04	14 x 1.5	8L	1/4		
51P-10411-14-05	METM-08L-05 X14ME08-05	14 x 1.5	8L	5/16		
51P-10411-16-04	METM-10L-04 X16ME10-04	16 x 1.5	10L	1/4		
51P-10411-16-05	METM-10L-05 X16ME10-05	16 x 1.5	10L	5/16		
51P-10411-16-06	METM-10L-06 X16ME10-06	16 x 1.5	10L	3/8		
51P-10411-18-04	METM-12L-04 X18ME12-04	18 x 1.5	12L	1/4		
51P-10411-18-06	METM-12L-06 X18ME12-06	18 x 1.5	12L	3/8		
51P-10411-22-06	METM-15L-06 X22ME15-06	22 x 1.5	15L	3/8		
51P-10411-22-08	METM-15L-08 X22ME15-08	22 x 1.5	15L	1/2		
51P-10411-26-08	METM-18L-08 X26ME18-08	26 x 1.5	18L	1/2		
51P-10411-26-10	METM-18L-10 X26ME18-10	26 x 1.5	18L	5/8		
51P-10411-30-12	METM-22L-12 X30ME22-12	30 x 2	22L	3/4		
51P-10411-36-16	METM-28L-16 X36ME28-16	36 x 2	28L	1		
51P-10411-45-20	METM-35L-20 X45ME35-20	45 x 2	35L	1 1/4		
51P-10411-52-24	METM-42L-24 X52ME42-24	52 x 2	42L	1 1/2		

METRIC SWAGE FITTINGS - HEAVY SERIES - STR MALE

Part No	Description	Thread	Pipe	Hose	Visual	Retail	
51P-10511-16-04	METM-08S-04 X16ME08-04	16 x 1.5	8S	1/4			
51P-10511-18-04	METM-10S-04 X18ME10-04	18 x 1.5	10S	1/4			
51P-10511-20-06	METM-12S-06 X20ME12-06	20 x 1.5	12S	3/8			
51P-10511-22-06	METM-14S-06 X22ME14-06	22 x 1.5	14S	3/8			
51P-10511-24-08	METM-16S-08 X24ME16-08	24 x 1.5	16S	1/2			
51P-10511-30-10	METM-20S-10 X30ME20-10	30 x 2	20S	5/8			
51P-10511-30-12	METM-20S-12 X30ME20-12	30 x 2	20S	3/4			
51P-10511-36-12	METM-25S-12 X36ME25-12	36 x 2	25S	3/4			
51P-10511-36-16	METM-25S-16 X36ME25-16	36 x 2	25S	1			
51P-10511-42-16	METM-30S-16 X42ME30-16	42 x 2	30S	1			
51P-10511-52-20	METM-38S-20 X52ME38-20	52 x 2	38S	1 1/4			

O.R.F.S. HOSE END

HOSE ENDS ARE SUITABLE FOR 1 - WIRE, 2 - WIRE & 4 - SPIRAL HOSES

Retail

Prices

ORFS HOSE FITTINGS - STRAIGHT

19-07-2023

Part No	Description	Thread	Hose	Visual	Retail
51P-24211-04-04	ORFS-04-04 X04LORF04	9/16" -18	1/4"		
51P-24211-06-04	ORFS-06-04 X06LORF04	9/16" - 18	1/4"		
51P-24211-06-06	ORFS-06-06 X06LORF06	11/16" -16	3/8"		
51P-24211-08-06	ORFS-08-06 X08LORF06	13/16" -16	3/8"		
51P-24211-08-08	ORFS-08-08 X08LORF08	13/16" -16	1/2"		
51P-24211-10-08	ORFS-10-08 X10LORF08	1" -14	1/2"		
51P-24211-10-10	ORFS-10-10 X10LORF10	1" -14	5/8"		
51P-24211-12-08	ORFS-12-08 X12LORF08	1 3/16"-12	1/2"		
51P-24211-12-10	ORFS-12-10 X12LORF10	1 3/16"-12	5/8"		
51P-24211-12-12	ORFS-12-12 X12LORF12	1 3/16"-12	3/4"		
51P-24211-16-12	ORFS-16-12 X16LORF12	1 7/16"-12	3/4"		
51P-24211-16-16	ORFS-16-16 X16LORF16	1 7/16"-12	1"		
51P-24211-20-20	ORFS-20-20 X20LORF20	1 11/16" -12	1 1/4"		
51P-24211-24-24	ORFS-24-24 X24LORF24	2 11/16" -12	1 1/4"		

ORFS HOSE FITTINGS - 45°

Part No	Description	Thread	Hose	Visual	Retail
51P-24241-04-04	ORFS45-04-04 X04LORF45S04	9/16" -18	1/4"		
51P-24241-06-06	ORFS45-06-06 X06LORF45S06	11/16" -16	3/8"		
51P-24241-08-06	ORFS45-08-06 X08LORF45S06	13/16" -16	3/8"		
51P-24241-08-08	ORFS45-08-08 X08LORF45S08	13/16" -16	1/2"		
51P-24241-10-08	ORFS45-10-08 X10LORF45S08	1" -14	1/2"		
51P-24241-10-10	ORFS45-10-10 X10LORF45S10	1" -14	5/8"		
51P-24241-12-12	ORFS45-12-12 X12LORF45S12	1 3/16"-12	3/4"		
51P-24241-16-16	ORFS45-16-16 X16LORF45S16	1 7/16"-12	1"		
51P-24241-20-20	ORFS45-20-20 X20LORF45S20	1 11/16" -12	1 1/4"		
51P-24241-24-24	ORFS45-24-24 X24LORF45S24	2 11/16" -12	1 1/4"		

ORFS HOSE FITTINGS - 90°

Part No	Description	Thread	Hose	Visual	Retail
51P-24291-04-04	ORFS90-04-04 X04LORF90S04	9/16" -18	1/4"		
51P-24291-06-04	ORFS90-06-04 X06LORF90S04	11/16" -16	1/4"		
51P-24291-06-06	ORFS90-06-06 X06LORF90S06	11/16" -16	3/8"		
51P-24291-08-06	ORFS90-08-06 X08LORF90S06	13/16" -16	3/8"		
51P-24291-08-08	ORFS90-08-08 X08LORF90S08	13/16" -16	1/2"		
51P-24291-10-08	ORFS90-10-08 X10LORF90S08	1" -14	1/2"		
51P-24291-10-10	ORFS90-10-10 X10LORF90S10	1" -14	5/8"		
51P-24291-12-08	ORFS90-12-08 X12LORF90S08	1 3/16"-12	1/2"		
51P-24291-12-10	ORFS90-12-10 X12LORF90S10	1 3/16"-12	5/8"		
51P-24291-12-12	ORFS90-12-12 X12LORF90S12	1 3/16"-12	3/4"		
51P-24291-16-12	ORFS90-16-12 X16LORF90S12	1 7/16"-12	3/4"		
51P-24291-16-16	ORFS90-16-16 X16LORF90S16	1 7/16"-12	1"		
51P-24291-20-20	ORFS90-20-20 X20LORF90S20	1 11/16" -12	1 1/4"		
51P-24291-24-24	ORFS90-24-24 X24LORF90S24	2 11/16" -12	1 1/4"		

ORFS MALE HOSE FITTINGS

Part No	Description	Thread	Hose	Visual	Retail
51P-14211-04-04	ORFSM-04-04 X04LORM04	9/16" -18	1/4"		
51P-14211-06-04	ORFSM-06-04 X06LORM04	11/16" -16	1/4"		
51P-14211-06-06	ORFSM-06-06 X06LORM06	11/16" -16	3/8"		
51P-14211-08-06	ORFSM-08-06 X08LORM06	13/16" -16	3/8"		
51P-14211-08-08	ORFSM-08-08 X08LORM08	13/16" -16	1/2"		
51P-14211-10-08	ORFSM-10-08 X10LORM08	1" -14	1/2"		
51P-14211-10-10	ORFSM-10-10 X10LORM10	1" -14	5/8"		
51P-14211-12-08	ORFSM-12-08 X12LORM08	1 3/16"-12	1/2"		
51P-14211-12-10	ORFSM-12-10 X12LORM10	1 3/16"-12	5/8"		
51P-14211-12-12	ORFSM-12-12 X12LORM12	1 3/16"-12	3/4"		
51P-14211-16-12	ORFSM-16-12 X16LORM12	1 11/16" -12	3/4"		
51P-14211-16-16	ORFSM-16-16 X16LORM16	1 11/16" -12	1 1/4"		

FLANGE - 3000 PSI HOSE END

HOSE ENDS ARE SUITABLE FOR 1-WIRE 2-WIRE & 4-SPIRAL HOSES

SOLID ONE PIECE FLANGES - STRAIGHT - 3000 PSI

Part No	Description	Flange	FI OD	Hose	Visual	Retail
51P-87311-08-08	SPLIT FL-3-08-08 S08SFH-3-08	1/2"	30.20 mm	1/2"		
51P-87311-12-08	SPLIT FL-3-12-08 S12SFH-3-08	3/4"	38.10 mm	1/2"		
51P-87311-12-12	SPLIT FL-3-12-12 S12SFH-3-12	3/4"	38.10 mm	3/4"		
51P-87311-12-16	SPLIT FL-3-12-16 S12SFH-3-16	3/4"	38.10 mm	1"		
51P-87311-16-12	SPLIT FL-3-16-12 S16SFH-3-12	1"	44.50 mm	3/4"		
51P-87311-16-16	SPLIT FL-3-16-16 S16SFH-3-16	1"	44.50 mm	1"		
51P-87311-16-20	SPLIT FL-3-16-20 S16SFH-3-20	1"	44.50 mm	1 1/4"		
51P-87311-20-16	SPLIT FL-3-20-16 S20SFH-3-16	1 1/4"	50.80 mm	1"		
51P-87311-20-20	SPLIT FL-3-20-20 S20SFH-3-20	1 1/4"	50.80 mm	1 1/4"		
51P-87311-24-20	SPLIT FL-3-24-20 S24SFH-3-20	1 1/2"	60.30 mm	1 1/4"		
51P-87311-24-24	SPLIT FL-3-24-24 S24SFH-3-24	1 1/2"	60.30 mm	1 1/2"		
51P-87311-32-24	SPLIT FL-3-32-24 S32SFH-3-24	2"	71.4 mm	1 1/2"		
51P-87311-32-32	SPLIT FL-3-32-32 S32SFH-3-32	2"	71.4 mm	2"		

SOLID ONE PIECE FLANGES - 45° - 3000 PSI

Part No	Description	Flange	FI OD	Hose	Visual	Retail
51P-87341-08-08	SPLIT FL-3-45-08-08 S08SFH45S-3-08	1/2"	30.20 mm	1/2"		
51P-87341-08-12	SPLIT FL-3-45-08-12 S08SFH45S-3-12	1/2"	30.20 mm	3/4"		
51P-87341-12-08	SPLIT FL-3-45-12-08 S12SFH45S-3-08	3/4"	38.10 mm	1/2"		
51P-87341-12-12	SPLIT FL-3-45-12-12 S12SFH45S-3-12	3/4"	38.10 mm	3/4"		
51P-87341-12-16	SPLIT FL-3-45-12-16 S12SFH45S-3-16	3/4"	38.10 mm	1"		
51P-87341-16-12	SPLIT FL-3-45-16-12 S16SFH45S-3-12	1"	44.50 mm	3/4"		
51P-87341-16-16	SPLIT FL-3-45-16-16 S16SFH45S-3-16	1"	44.50 mm	1"		
51P-87341-16-20	SPLIT FL-3-45-16-20 S16SFH45S-3-20	1"	44.50 mm	1 1/4"		
51P-87341-20-16	SPLIT FL-3-45-20-16 S20SFH45S-3-16	1 1/4"	50.80 mm	1"		
51P-87341-20-20	SPLIT FL-3-45-20-20 S20SFH45S-3-20	1 1/4"	50.80 mm	1 1/4"		
51P-87341-24-20	SPLIT FL-3-45-24-20 S24SFH45S-3-20	1 1/2"	60.30 mm	1 1/4"		
51P-87341-24-24	SPLIT FL-3-45-24-24 S24SFH45S-3-24	1 1/2"	60.30 mm	1 1/2"		
51P-87341-32-24	SPLIT FL-3-45-32-24 S32SFH45S-3-24	2"	71.4 mm	1 1/2"		
51P-87341-32-32	SPLIT FL-3-45-32-32 S32SFH45S-3-32	2"	71.4 mm	2"		

SOLID ONE PIECE FLANGES - 90° - 3000 PSI

Part No	Description	Flange	FI OD	Hose	Visual	Retail	
51P-87391-08-08	SPLIT FL-90-3-08-08 S08SFH90S-3-08	1/2"	30.20 mm	1/2"			
51P-87391-12-08	SPLIT FL-90-3-12-08 S12SFH90S-3-08	3/4"	38.10 mm	1/2"			
51P-87391-12-12	SPLIT FL-90-3-12-12 S12SFH90S-3-12	3/4"	38.10 mm	3/4"			
51P-87391-12-16	SPLIT FL-90-3-12-16 S12SFH90S-3-16	3/4"	38.10 mm	1"			
51P-87391-16-12	SPLIT FL-90-3-16-12 S16SFH90S-3-12	1"	44.50 mm	3/4"			
51P-87391-16-16	SPLIT FL-90-3-16-16 S16SFH90S-3-16	1"	44.50 mm	1"			
51P-87391-16-20	SPLIT FL-90-3-16-20 S16SFH90S-3-20	1"	44.50 mm	1 1/4"			
51P-87391-20-16	SPLIT FL-90-3-20-16 S20SFH90S-3-16	1 1/4"	50.80 mm	1"			
51P-87391-20-20	SPLIT FL-90-3-20-20 S20SFH90S-3-20	1 1/4"	50.80 mm	1 1/4"			
51P-87391-24-20	SPLIT FL-90-3-24-20 S24SFH90S-3-20	1 1/2"	60.30 mm	1 1/4"			
51P-87391-24-24	SPLIT FL-90-3-24-24 S24SFH90S-3-24	1 1/2"	60.30 mm	1 1/2"			
51P-87391-32-24	SPLIT FL-90-3-32-24 S32SFH90S-3-24	2"	71.4 mm	1 1/2"			
51P-87391-32-32	SPLIT FL-90-3-32-32 S32SFH90S-3-32	2"	71.4 mm	2"			

FLANGE - 6000 PSI HOSE END

Retail

HOSE ENDS ARE SUITABLE FOR 1-WIRE 2-WIRE & 4-SPIRAL HOSES

Prices

SOLID ONE PIECE FLANGE - 6000 PSI

19-07-2023

Part No	Description	Flange	FI OD	Hose	Visual	Retail
51P-87611-08-08	SPLIT FL-6-08-08 S08SFH-6-08	1/2"	31.70mm	1/2"		
51P-87611-12-08	SPLIT FL-6-12-08 S12SFH-6-08	3/4"	41.30 mm	1/2"		
51P-87611-12-12	SPLIT FL-6-12-12 S12SFH-6-12	3/4"	41.30 mm	3/4"		
51P-87611-12-16	SPLIT FL-6-12-16 S12SFH-6-16	3/4"	41.30 mm	1"		
51P-87611-16-12	SPLIT FL-6-16-12 S16SFH-6-12	1"	47.60 mm	3/4"		
51P-87611-16-16	SPLIT FL-6-16-16 S16SFH-6-16	1"	47.60 mm	1"		
51P-87611-16-20	SPLIT FL-6-16-20 S16SFH-6-20	1"	47.60 mm	1 1/4"		
51P-87611-20-16	SPLIT FL-6-20-16 S20SFH-6-16	1 1/4"	54.00 mm	1"		
51P-87611-20-20	SPLIT FL-6-20-20 S20SFH-6-20	1 1/4"	54.00 mm	1 1/4"		
51P-87611-24-20	SPLIT FL-6-24-20 S24SFH-6-20	1 1/2"	63.50 mm	1 1/4"		
51P-87611-24-24	SPLIT FL-6-24-24 S24SFH-6-24	1 1/2"	63.50 mm	1 1/2"		
51P-87611-32-24	SPLIT FL-6-32-24 S32SFH-6-24	2"	79.40 mm	1 1/2"		
51P-87611-32-32	SPLIT FL-6-32-32 S32SFH-6-32	2"	79.40 mm	2"		

SOLID ONE PIECE FLANGE - 45° - 6000 PSI

Part No	Description	Flange	FI OD	Hose	Visual	Retail
51P-87641-08-08	SPLIT FL-45-6-08-08 S08SFH45S-6-08	1/2"	31.70 mm	1/2"		
51P-87641-12-08	SPLIT FL-45-6-12-08 S12SFH45S-6-08	3/4"	41.30 mm	1/2"		
51P-87641-12-12	SPLIT FL-45-6-12-12 S12SFH45S-6-12	3/4"	41.30 mm	3/4"		
51P-87641-12-16	SPLIT FL-45-6-12-16 S12SFH45S-6-16	3/4"	41.30 mm	1"		
51P-87641-16-12	SPLIT FL-45-6-16-12 S16SFH45S-6-12	1"	47.60 mm	3/4"		
51P-87641-16-16	SPLIT FL-45-6-16-16 S16SFH45S-6-16	1"	47.60 mm	1"		
51P-87641-16-20	SPLIT FL-45-6-16-20 S16SFH45S-6-20	1"	47.60 mm	1 1/4"		
51P-87641-20-16	SPLIT FL-45-6-20-16 S20SFH45S-6-16	1 1/4"	54.00 mm	1"		
51P-87641-20-20	SPLIT FL-45-6-20-20 S20SFH45S-6-20	1 1/4"	54.00 mm	1 1/4"		
51P-87641-24-20	SPLIT FL-45-6-24-20 S24SFH45S-6-20	1 1/2"	63.50 mm	1 1/4"		
51P-87641-24-24	SPLIT FL-45-6-24-24 S24SFH45S-6-24	1 1/2"	63.50 mm	1 1/2"		
51P-87641-32-24	SPLIT FL-45-6-32-24 S32SFH45S-6-24	2"	79.40 mm	1 1/2"		
51P-87641-32-32	SPLIT FL-45-6-32-32 S32SFH45S-6-32	2"	79.40 mm	2"		

SOLID ONE PIECE FLANGE - 90° - 6000 Psi

Part No	Description	Flange	FI OD	Hose	Visual	Retail	
51P-87691-08-08	SPLIT FL-90-6-08-08 S08SFH90S-6-08	1/2"	31.70 mm	1/2"			
51P-87691-08-12	SPLIT FL-90-6-08-12 S08SFH90S-6-12	3/4"	41.30 mm	1/2"			
51P-87691-12-12	SPLIT FL-90-6-12-12 S12SFH90S-6-12	3/4"	41.30 mm	3/4"			
51P-87691-12-16	SPLIT FL-90-6-12-16 S12SFH90S-6-16	3/4"	41.30 mm	1"			
51P-87691-16-12	SPLIT FL-90-6-16-12 S16SFH90S-6-12	1"	47.60 mm	3/4"			
51P-87691-16-16	SPLIT FL-90-6-16-16 S16SFH90S-6-16	1"	47.60 mm	1"			
51P-87691-16-20	SPLIT FL-90-6-16-20 S16SFH90S-6-20	1"	47.60 mm	1 1/4"			
51P-87691-20-16	SPLIT FL-90-6-20-16 S20SFH90S-6-16	1 1/4"	54.00 mm	1"			
51P-87691-20-20	SPLIT FL-90-6-20-20 S20SFH90S-6-20	1 1/4"	54.00 mm	1 1/4"			
51P-87691-24-20	SPLIT FL-90-6-24-20 S24SFH90S-6-20	1 1/2"	63.50 mm	1 1/4"			
51P-87691-24-24	SPLIT FL-90-6-24-24 S24SFH90S-6-24	1 1/2"	63.50 mm	1 1/2"			
51P-87691-32-24	SPLIT FL-90-6-32-24 S32SFH90S-6-24	2"	79.40 mm	1 1/2"			
51P-87691-32-32	SPLIT FL-90-6-32-32 S32SFH90S-6-32	2"	79.40 mm	2"			

ASSORTED HOSE ENDS

HOSE ENDS ARE SUITABLE FOR 1 - WIRE, 2 - WIRE & 4 - SPIRAL HOSES

Retail

Prices

HOSE JOINERS

19-07-2023

Part No.	Description	Size	Size	Visual	Retail
51P-90011-04	HOSE JOINER HJ-04 X04H/J	1/4"	1/4"		
51P-90011-05	HOSE JOINER HJ-05 X05H/J	5/16"	5/16"		
51P-90011-06	HOSE JOINER HJ-06 X06H/J	3/8"	3/8"		
51P-90011-08	HOSE JOINER HJ-08 X08H/J	1/2"	1/2"		
51P-90011-10	HOSE JOINER HJ-10 X10H/J	5/8"	5/8"		
51P-90011-12	HOSE JOINER HJ-12 X12H/J	3/4"	3/4"		
51P-90011-16	HOSE JOINER HJ-16 X16H/J	1"	1"		
51P-90011-20	HOSE JOINER HJ-20 X20H/J	1 1/4"	1 1/4"		
51P-90011-24	HOSE JOINER HJ-24 X24H/J	1 1/2"	1 1/2"		

BLANK TAILS

Part No	Description	Size	Visual	Retail
51P-90011B-04	BLANK TAIL STS-04 X04B/T	1/4"		
51P-90011B-05	BLANK TAIL STS-05 X05B/T	5/16"		
51P-90011B-06	BLANK TAIL STS-06 X06B/T	3/8"		
51P-90011B-08	BLANK TAIL STS-08 X08B/T	1/2"		
51P-90011B-10	BLANK TAIL STS-10 X10B/T	5/8"		
51P-90011B-12	BLANK TAIL STS-12 X12B/T	3/4"		
51P-90011B-16	BLANK TAIL STS-16 X16B/T	1"		
51P-90011B-20	BLANK TAIL STS-20 X20B/T	1 1/4"		
51P-90011B-24	BLANK TAIL STS-24 X24B/T	1 1/2"		
51P-90011B-32	BLANK TAIL STS-32 X32B/T	2"		

HIGH PRESSURE WATER HOSE FITTINGS

Part No	Description	Thread	Hose	Visual	Retail
51P-200112204T	WATERWASHER X22MSF15-04K	22 x 1.5	1/4"		
51P-200112205T	WATERWASHER X22MSF15-05K	22 x 1.5	5/16"		
51P-200112206T	WATERWASHER X22MSF15-06K	22 x 1.5	3/8"		

PUSH-ON HOSE ENDS

HOSE ENDS ARE SUITABLE FOR 1 - WIRE, 2 - WIRE & 4 - SPIRAL HOSES

Retail

Prices

NPT MALE PUSH-ON

01-10-2022

Part No.	Description	NPT	Hose	Visual	Retail
51P-PO156110204	NPT MALE PUSH - ON 02-04	1/8"	1/4"		
51P-PO156110404	NPT MALE PUSH - ON 04-04	1/4"	1/4"		
51P-PO156110406	NPT MALE PUSH - ON 04-06	1/4"	3/8"		
51P-PO156110606	NPT MALE PUSH - ON 06-06	3/8"	3/8"		
51P-PO156110608	NPT MALE PUSH - ON 06-08	3/8"	1/2"		
51P-PO156110808	NPT MALE PUSH - ON 08-08	1/2"	1/2"		
51P-PO156110810	NPT MALE PUSH - ON 08-10	1/2"	5/8"		
51P-PO156111212	NPT MALE PUSH - ON 12-12	3/4"	3/4"		

BSPP MALE PUSH-ON

Part No	Description	BSPP	Hose	Visual	Retail
51P-PO126110404	BSPP MALE PUSH - ON 04-04	1/4"	1/4"		
51P-PO126110606	BSPP MALE PUSH - ON 06-06	3/8"	3/8"		
51P-PO126110808	BSPP MALE PUSH - ON 08-08	1/2"	1/2"		
51P-PO126111010	BSPP MALE PUSH - ON 10-10	5/8"	5/8"		
51P-PO126111212	BSPP MALE PUSH - ON 12-12	3/4"	3/4"		

BSPP FEMALE PUSH-ON

Part No	Description	BSPP	Hose	Visual	Retail
51P-PO226110404	BSPP FEMALE PUSH - ON 04-04	1/4"	1/4"		
51P-PO226110606	BSPP FEMALE PUSH - ON 06-06	3/8"	3/8"		
51P-PO226110808	BSPP FEMALE PUSH - ON 08-08	1/2"	1/2"		
51P-PO226111212	BSPP FEMALE PUSH - ON 12-12	3/4"	3/4"		

JIC FEMALE PUSH-ON

Part No	Description	JIC	Hose	Visual	Retail	
51P-PO267110404	JIC FEMALE PUSH - ON 04-04	-04	1/4"			
51P-PO267110504	JIC FEMALE PUSH - ON 05-04	-05	1/4"			
51P-PO267110606	JIC FEMALE PUSH - ON 06-06	-06	3/8"			
51P-PO267110806	JIC FEMALE PUSH - ON 08-06	-08	3/8"			
51P-PO267110808	JIC FEMALE PUSH - ON 08-08	-08	1/2"			
51P-PO267111008	JIC FEMALE PUSH - ON 10-08	-10	1/2"			
51P-PO267111010	JIC FEMALE PUSH - ON 10-10	-10	5/8"			
51P-PO267111212	JIC FEMALE PUSH - ON 12-12	-12	3/4"			

PIPE TO PIPE PUSH-ON

Part No	Description	Hose	Hose	Visual	Retail
51P-PO90011-04	PIPE TO PIPE PUSH - ON 04-04	1/4"	1/4"		
51P-PO90011-05	PIPE TO PIPE PUSH - ON 05-05	5/16"	5/16"		
51P-PO90011-06	PIPE TO PIPE PUSH - ON 06-06	3/8"	3/8"		
51P-PO90011-08	PIPE TO PIPE PUSH - ON 08-08	1/2"	1/2"		
51P-PO90011-10	PIPE TO PIPE PUSH - ON 10-10	5/8"	5/8"		
51P-PO90011-12	PIPE TO PIPE PUSH - ON 12-12	3/4"	3/4"		

B.S.P. ADAPTORS

Retail

Prices

BSP MALE X BSP MALE

19-07-2023

Part No	Description	Bsp	Bsp	Visual	Retail
54P-1B-02	BSPM X BSPM-02-02 HNB-02-02	1/8"	1/8"		
54P-1B-02-04	BSPM X BSPM-02-04 HNB-04-02	1/4"	1/8"		
54P-1B-04	BSPM X BSPM-04-04 HNB-04-04	1/4"	1/4"		
54P-1B-04-06	BSPM X BSPM-04-06 HNB-06-04	3/8"	1/4"		
54P-1B-04-08	BSPM X BSPM-04-08 HNB-08-04	1/2"	1/4"		
54P-1B-06	BSPM X BSPM-06-06 HNB-06-06	3/8"	3/8"		
54P-1B-06-08	BSPM X BSPM-06-08 HNB-08-06	1/2"	3/8"		
54P-1B-06-12	BSPM X BSPM-06-12 HNB-12-06	3/4"	3/8"		
54P-1B-08	BSPM X BSPM-08-08 HNB-08-08	1/2"	1/2"		
54P-1B-08-10	BSPM X BSPM-08-10 HNB-10-08	5/8"	1/2"		
54P-1B-08-12	BSPM X BSPM-08-12 HNB-12-08	3/4"	1/2"		
54P-1B-08-16	BSPM X BSPM-08-16 HNB-16-08	1"	1/2"		
54P-1B-10	BSPM X BSPM-10-10 HNB-10-10	5/8"	5/8"		
54P-1B-12	BSPM X BSPM-12-12 HNB-12-12	3/4"	3/4"		
54P-1B-12-10	BSPM X BSPM-12-10 HNB-10-12	5/8"	3/4"		
54P-1B-12-16	BSPM X BSPM-12-16 HNB-16-12	1"	3/4"		
54P-1B-16	BSPM X BSPM-16-16 HNB-16-16	1"	1"		
54P-1B-16-20	BSPM X BSPM-16-20 HNB-20-16	1 1/4"	1"		
54P-1B-16-24	BSPM X BSPM-16-24 HNB-24-16	1 1/2"	1"		
54P-1B-20	BSPM X BSPM-20-20 HNB-20-20	1 1/4"	1 1/4"		
54P-1B-20-12	BSPM X BSPM-20-12 HNB-12-20	3/4"	1 1/4"		
54P-1B-20-24	BSPM X BSPM-20-24 HNB-24-20	1 1/2"	1 1/4"		
54P-1B-24	BSPM X BSPM-24-24 HNB-24-24	1 1/2"	1 1/2"		
54P-1B-24-32	BSPM X BSPM-24-32 HNB-32-24	2"	1 1/2"		
54P-1B-32	BSPM X BSPM-32-32 HNB-32-32	2"	2"		

BSP MALE X BSP MALE 90°

Part No	Description	Bsp	Bsp	Visual	Retail
54P-1B9-04-04	BSPM X BSPM-90-04-04	1/4"	1/4"		
54P-1B9-06-06	BSPM X BSPM-90-06-06	3/8"	3/8"		
54P-1B9-08-08	BSPM X BSPM-90-08-08	1/2"	1/2"		
54P-1B9-12-12	BSPM X BSPM-90-12-12	3/4"	3/4"		
54P-1B9-16-16	BSPM X BSPM-90-16-16	1"	1"		

B.S.P. ADAPTORS

Retail

Prices

BSP MALE X BSP MALE O RING ADJUSTABLE 90°

19-07-2023

Part No	Description	Bsp	Bsp	Visual	Retail
54P-1BG9-OG-04	BSPM X BSPM-OG-90-04-04	1/4"	1/4"		
54P-1BG9-OG-06	BSPM X BSPM-OG-90-06-06	3/8"	3/8"		
54P-1BG9-OG-08	BSPM X BSPM-OG-90-08-08	1/2"	1/2"		
54P-1BG9-OG-12	BSPM X BSPM-OG-90-12-12	3/4"	3/4"		
54P-1BG9-OG-16	BSPM X BSPM-OG-90-16-16	1"	1"		

BSP MALE X JIC MALE STRAIGHT

Part No	Description	Jic	Bsp	Visual	Retail
54P-1BJ-02-04	JICM X BSPM-04-02 MCJB-04-02	7/16"	1/8"		
54P-1BJ-04	JICM X BSPM-04-04 MCJB-04-04	7/16"	1/4"		
54P-1BJ-04-05	JICM X BSPM-05-04 MCJB-05-04	1/2"	1/4"		
54P-1BJ-04-06	JICM X BSPM-06-04 MCJB-06-04	9/16"	1/4"		
54P-1BJ-04-08	JICM X BSPM-08-04 MCJB-08-04	3/4"	1/4"		
54P-1BJ-06-04	JICM X BSPM-04-06 MCJB-04-06	7/16"	3/8"		
54P-1BJ-06	JICM X BSPM-06-06 MCJB-06-06	9/16"	3/8"		
54P-1BJ-06-08	JICM X BSPM-08-06 MCJB-08-06	3/4"	3/8"		
54P-1BJ-06-10	JICM X BSPM-10-06 MCJB-10-06	7/8"	3/8"		
54P-1BJ-08-04	JICM X BSPM-04-08 MCJB-04-08	7/16"	1/2"		
54P-1BJ-08-06	JICM X BSPM-06-08 MCJB-06-08	9/16"	1/2"		
54P-1BJ-08	JICM X BSPM-08-08 MCJB-08-08	3/4"	1/2"		
54P-1BJ-08-10	JICM X BSPM-10-08 MCJB-10-08	7/8"	1/2"		
54P-1BJ-08-12	JICM X BSPM-12-08 MCJB-12-08	1 1/16"	1/2"		
54P-1BJ-10-06	JICM X BSPM-06-10 MCJB-06-10	9/16"	5/8"		
54P-1BJ-10-08	JICM X BSPM-08-10 MCJB-08-10	3/4"	5/8"		
54P-1BJ-10	JICM X BSPM-10-10 MCJB-10-10	7/8"	5/8"		
54P-1BJ-10-12	JICM X BSPM-12-10 MCJB-12-10	1 1/16"	5/8"		
54P-1BJ-12-06	JICM X BSPM-06-12 MCJB-06-12	9/16"	3/4"		
54P-1BJ-12-08	JICM X BSPM-08-12 MCJB-08-12	3/4"	3/4"		
54P-1BJ-12-10	JICM X BSPM-10-12 MCJB-10-12	7/8"	3/4"		
54P-1BJ-12	JICM X BSPM-12-12 MCJB-12-12	1 1/16"	3/4"		
54P-1BJ-12-16	JICM X BSPM-16-12 MCJB-16-12	1 5/16"	3/4"		
54P-1BJ-16-08	JICM X BSPM-08-16 MCJB-08-16	3/4"	1"		
54P-1BJ-16-12	JICM X BSPM-12-16 MCJB-12-16	1 1/16"	1"		
54P-1BJ-16	JICM X BSPM-16-16 MCJB-16-16	1 5/16"	1"		
54P-1BJ-16-20	JICM X BSPM-20-16 MCJB-20-16	1 5/8"	1"		
54P-1BJ-20-12	JICM X BSPM-20-12 MCJB-12-20	1 1/16"	1 1/4"		
54P-1BJ-20	JICM X BSPM-20-20 MCJB-20-20	1 5/8"	1 1/4"		
54P-1BJ-20-16	JICM X BSPM-20-16 MCJB-16-20	1 5/16"	1 1/4"		
54P-1BJ-20-24	JICM X BSPM-24-20 MCJB-24-20	1 7/8"	1 1/4"		
54P-1BJ-24-16	JICM X BSPM-16-24 MCJB-16-24	1 5/16"	1 1/2"		
54P-1BJ-24-20	JICM X BSPM-20-24 MCJB-20-24	1 5/8"	1 1/2"		
54P-1BJ-24	JICM X BSPM-24-24 MCJB-24-24	1 7/8"	1 1/2"		
54P-1BJ-32	JICM X BSPM-32-32 MCJB-32-32	2 1/2"	2"		

B.S.P. ADAPTORS

Retail

Prices

BSP MALE X NPT MALE

19-09-2023

Part No	Description	Bsp	Npt	Visual	Retail
54P-1BN-02-02	BSPM X NPTM HNBT-02-02	1/8"	1/8"		
54P-1BN-04-02	BSPM X NPTM HNBT-02-04	1/4"	1/8"		
54P-1BN-04-04	BSPM X NPTM HNBT-04-04	1/4"	1/4"		
54P-1BN-04-06	BSPM X NPTM HNBT-06-04	1/4"	3/8"		
54P-1BN-04-08	BSPM X NPTM HNBT-08-04	1/4"	1/2"		
54P-1BN-06-04	BSPM X NPTM HNBT-04-06	3/8"	1/4"		
54P-1BN-06-06	BSPM X NPTM HNBT-06-06	3/8"	3/8"		
54P-1BN-06-08	BSPM X NPTM HNBT-08-06	3/8"	1/2"		
54P-1BN-08-04	BSPM X NPTM HNBT-04-08	1/2"	1/4"		
54P-1BN-08-06	BSPM X NPTM HNBT-06-08	1/2"	3/8"		
54P-1BN-08-08	BSPM X NPTM HNBT-08-08	1/2"	1/2"		
54P-1BN-08-12	BSPM X NPTM HNBT-12-08	1/2"	3/4"		
54P-1BN-08-16	BSPM X NPTM HNBT-16-08	1/2"	1"		
54P-1BN-10-06	BSPM X NPTM HNBT-06-10	5/8"	3/8"		
54P-1BN-10-08	BSPM X NPTM HNBT-08-10	5/8"	1/2"		
54P-1BN-10-10	BSPM X NPTM HNBT-10-10	5/8"	5/8"		
54P-1BN-12-06	BSPM X NPTM HNBT-06-12	3/4"	3/8"		
54P-1BN-12-08	BSPM X NPTM HNBT-08-12	3/4"	1/2"		
54P-1BN-12-12	BSPM X NPTM HNBT-12-12	3/4"	3/4"		
54P-1BN-12-16	BSPM X NPTM HNBT-16-12	3/4"	1"		
54P-1BN-16-08	BSPM X NPTM HNBT-08-16	1"	1/2"		
54P-1BN-16-12	BSPM X NPTM HNBT-12-16	1"	3/4"		
54P-1BN-16-16	BSPM X NPTM HNBT-16-16	1"	1"		
54P-1BN-16-20	BSPM X NPTM HNBT-20-16	1"	1 1/4"		
54P-1BN-20-16	BSPM X NPTM HNBT-16-20	1 1/4"	1"		
54P-1BN-20-20	BSPM X NPTM HNBT-20-20	1 1/4"	1 1/4"		
54P-1BN-20-24	BSPM X NPTM HNBT-24-20	1 1/4"	1 1/2"		
54P-1BN-24-20	BSPM X NPTM HNBT-20-24	1 1/2"	1 1/4"		
54P-1BN-24-24	BSPM X NPTM HNBT-24-24	1 1/2"	1 1/2"		
54P-1BN-32-20	BSPM X NPTM HNBT-20-32	2"	1 1/4"		
54P-1BN-32-24	BSPM X NPTM HNBT-24-32	2"	1 1/2"		
54P-1BN-32-32	BSPM X NPTM HNBT-32-32	2"	2"		

BSP MALE X NPT MALE 90°

Part No	Description	Bsp	Npt	Visual	Retail	
54P-1BN9-04	BSPM X NPTM-90-04-04	1/4"	1/4"			
54P-1BN9-04-02	BSPM X NPTM-90-04-02	1/4"	1/8"			
54P-1BN9-06	BSPM X NPTM-90-06-06	3/8"	3/8"			
54P-1BN9-06-04	BSPM X NPTM-90-06-04	3/8"	1/4"			
54P-1BN9-06-08	BSPM X NPTM-90-06-08	3/8"	1/2"			
54P-1BN9-06-12	BSPM X NPTM-90-06-12	3/8"	3/4"			
54P-1BN9-08	BSPM X NPTM-90-08-08	1/2"	1/2"			
54P-1BN9-08-06	BSPM X NPTM-90-08-06	1/2"	3/8"			
54P-1BN9-12	BSPM X NPTM-90-12-12	3/4"	3/4"			
54P-1BN9-12-08	BSPM X NPTM-90-12-08	3/4"	1/2"			
54P-1BN9-12-16	BSPM X NPTM-90-12-16	3/4"	1"			
54P-1BN9-16	BSPM X NPTM-90-16-16	1"	1"			
54P-1BN9-16-12	BSPM X NPTM-90-16-12	1"	3/4"			

B.S.P. ADAPTORS

Retail

Prices

30-03-2023

BSP MALE X BSP FEMALE SWIVEL

Part No	Description	Bsp	Bsp	Visual	Retail
54P-2B-02	BSPM X BSPF-02-02	1"8"	1"8"		
54P-2B-02-04	BSPM X BSPF-02-04	1"8"	1"4"		
54P-2B-04	BSPM X BSPF-04-04	1"4"	1"4"		
54P-2B-04-06	BSPM X BSPF-04-06	1"4"	3"8"		
54P-2B-04-08	BSPM X BSPF-04-08	1"4"	1"2"		
54P-2B-06	BSPM X BSPF-06-06	3"8"	3"8"		
54P-2B-06-08	BSPM X BSPF-06-08	3"8"	1"2"		
54P-2B-06-10	BSPM X BSPF-06-10	3"8"	5"8"		
54P-2B-08	BSPM X BSPF-08-08	1"2"	1"2"		
54P-2B-08-06	BSPM X BSPF-08-06	1"2"	3"8"		
54P-2B-08-12	BSPM X BSPF-08-12	1"2"	3"4"		
54P-2B-10	BSPM X BSPF-10-10	5"8"	5"8"		
54P-2B-10-08	BSPM X BSPF-10-08	5"8"	1"2"		
54P-2B-10-12	BSPM X BSPF-10-12	5"8"	3"4"		
54P-2B-12	BSPM X BSPF-12-12	3"4"	3"4"		
54P-2B-12-10	BSPM X BSPF-12-10	3"4"	5"8"		
54P-2B-12-16	BSPM X BSPF-12-16	3"4"	1"		
54P-2B-16-16	BSPM X BSPF-16-16	1"	1"		
54P-2B-16-12	BSPM X BSPF-16-12	1"	3"4"		
54P-2B-16-20	BSPM X BSPF-16-20	1"	1 1"4"		
54P-2B-20	BSPM X BSPF-20-20	1 1"4"	1 1"4"		
54P-2B-20-16	BSPM X BSPF-20-16	1 1"4"	1"		
54P-2B-20-24	BSPM X BSPF-20-24	1 1"4"	1 1"2"		
54P-2B-24	BSPM X BSPF-24-24	1 1"2"	1 1"2"		
54P-2B-32	BSPM X BSPF-32-32	2"	2"		

BSP MALE X BSP FEMALE 45° SWIVEL

Part No	Description	Bsp	Bsp	Visual	Retail
54P-2B4-04	BSPM X BSPF-45-04-04	1"4"	1"4"		
54P-2B4-04-06	BSPM X BSPF-45-04-06	1"4"	3"8"		
54P-2B4-06	BSPM X BSPF-45-06-06	3"8"	3"8"		
54P-2B4-06-04	BSPM X BSPF-45-06-04	3"8"	1"4"		
54P-2B4-08	BSPM X BSPF-45-08-08	1"2"	1"2"		
54P-2B4-08-06	BSPM X BSPF-45-08-06	1"2"	3"8"		
54P-2B4-10	BSPM X BSPF-45-10-10	5"8"	5"8"		
54P-2B4-10-08	BSPM X BSPF-45-10-08	5"8"	1"2"		
54P-2B4-12	BSPM X BSPF-45-12-12	3"4"	3"4"		
54P-2B4-16	BSPM X BSPF-45-16-16	1"	1"		
54P-2B4-20	BSPM X BSPF-45-20-20	1 1"4"	1 1"4"		
54P-2B4-24	BSPM X BSPF-45-24-24	1 1"2"	1 1"2"		
54P-2B4-32	BSPM X BSPF-45-32-32	2"	2"		

B.S.P. ADAPTORS

Retail

Prices

BSP MALE X BSP FEMALE 90° SWIVEL

19-07-2023

Part No	Description	Bspp	Bspp	Visual	Retail
54P-2B9-02	BSPM X BSPF-90-02-02	1/8"	1/8"		
54P-2B9-04	BSPM X BSPF-90-04-04	1/4"	1/4"		
54P-2B9-06	BSPM X BSPF-90-06-06	3/8"	3/8"		
54P-2B9-08	BSPM X BSPF-90-08-08	1/2"	1/2"		
54P-2B9-10	BSPM X BSPF-90-10-10	5/8"	5/8"		
54P-2B9-12	BSPM X BSPF-90-12-12	3/4"	3/4"		
54P-2B9-16	BSPM X BSPF-90-16-16	1"	1"		
54P-2B9-20	BSPM X BSPF-90-20-20	1 1/4"	1 1/4"		

BSP FEMALE SWIVEL X BSP FEMALE SWIVEL

Part No	Description	Bspp	Bspp	Visual	Retail
54P-3B-02	BSPF X BSPF-02-02	1/8"	1/8"		
54P-3B-04	BSPF X BSPF-04-04	1/4"	1/4"		
54P-3B-06	BSPF X BSPF-06-06	3/8"	3/8"		
54P-3B-08	BSPF X BSPF-08-08	1/2"	1/2"		
54P-3B-10	BSPF X BSPF-10-10	5/8"	5/8"		
54P-3B-12	BSPF X BSPF-12-12	3/4"	3/4"		
54P-3B-16	BSPF X BSPF-16-16	1"	1"		
54P-3B-20	BSPF X BSPF-20-20	1 1/4"	1 1/4"		

BSP MALE PLUG HEX

Part No	Description	Size		Visual	Retail
54P-4B-02	BSPM HEX PLUG-02 HPB-02	1/8"			
54P-4B-04	BSPM HEX PLUG-04 HPB-04	1/4"			
54P-4B-06	BSPM HEX PLUG-06 HPB-06	3/8"			
54P-4B-08	BSPM HEX PLUG-08 HPB-08	1/2"			
54P-4B-10	BSPM HEX PLUG-10 HPB-10	5/8"			
54P-4B-12	BSPM HEX PLUG-12 HPB-12	3/4"			
54P-4B-16	BSPM HEX PLUG-16 HPB-16	1"			
54P-4B-20	BSPM HEX PLUG-20 HPB-20	1 1/4"			
54P-4B-24	BSPM HEX PLUG-24 HPB-24	1 1/2"			
54P-4B-32	BSPM HEX PLUG-32 HPB-32	2"			

BSP MALE PLUG IN - HEX

Part No	Description	Size		Visual	Retail
54P-4BN-02WD	BSPM ALLEN KEY-02 VSTI	1/8"			
54P-4BN-04WD	BSPM ALLEN KEY-04 VSTI	1/4"			
54P-4BN-06WD	BSPM ALLEN KEY-06 VSTI	3/8"			
54P-4BN-08WD	BSPM ALLEN KEY-08 VSTI	1/2"			
54P-4BN-10WD	BSPM ALLEN KEY-10 VSTI	5/8"			
54P-4BN-12WD	BSPM ALLEN KEY-12 VSTI	3/4"			
54P-4BN-16WD	BSPM ALLEN KEY-16 VSTI	1"			
54P-4BN-20WD	BSPM ALLEN KEY-16 VSTI	1 1/4"			
54P-4BN-24WD	BSPM ALLEN KEY-24 VSTI	1 1/2"			

BSPT MALE PLUG IN - HEX

Part No	Description	Size		Visual	Retail
54P-4TN-04	BSPT ALLEN KEY-04	1/4"			
54P-4TN-06	BSPT ALLEN KEY-06	3/8"			
54P-4TN-08	BSPT ALLEN KEY-08	1/2"			

B.S.P. ADAPTORS

Retail

Prices

BSP MALE X BSP FEMALE FIXED REDUCERS

19-07-2023

Part No	Description	Size	Size	Visual	Retail
54P-5B-02	BSPM X BSPF-02-02 FIXED REDUCER	1/8"	1/8"		
54P-5B-02-04	BSPM X BSPF-02-04 FIXED REDUCER	1/8"	1/4"		
54P-5B-04-02	BSPM X BSPF-04-02 FIXED REDUCER	1/4"	1/8"		
54P-5B-04	BSPM X BSPF-04-04 FIXED REDUCER	1/4"	1/4"		
54P-5B-04-06	BSPM X BSPF-04-06 FIXED REDUCER	1/4"	3/8"		
54P-5B-04-08	BSPM X BSPF-04-08 FIXED REDUCER	1/4"	1/2"		
54P-5B-06-04	BSPM X BSPF-06-04 FIXED REDUCER	3/8"	1/4"		
54P-5B-06	BSPM X BSPF-06-06 FIXED REDUCER	3/8"	3/8"		
54P-5B-06-08	BSPM X BSPF-06-08 FIXED REDUCER	3/8"	1/2"		
54P-5B-08-04	BSPM X BSPF-08-04 FIXED REDUCER	1/2"	1/4"		
54P-5B-08-06	BSPM X BSPF-08-06 FIXED REDUCER	1/2"	3/8"		
54P-5B-08	BSPM X BSPF-08-08 FIXED REDUCER	1/2"	1/2"		
54P-5B-08-10	BSPM X BSPF-08-10 FIXED REDUCER	1/2"	5/8"		
54P-5B-08-12	BSPM X BSPF-08-12 FIXED REDUCER	1/2"	3/4"		
54P-5B-10-08	BSPM X BSPF-10-08 FIXED REDUCER	5/8"	1/2"		
54P-5B-12-04	BSPM X BSPF-12-04 FIXED REDUCER	3/4"	1/4"		
54P-5B-12-06	BSPM X BSPF-12-06 FIXED REDUCER	3/4"	3/8"		
54P-5B-12-08	BSPM X BSPF-12-08 FIXED REDUCER	3/4"	1/2"		
54P-5B-12	BSPM X BSPF-12-12 FIXED REDUCER	3/4"	3/4"		
54P-5B-12-16	BSPM X BSPF-12-16 FIXED REDUCER	3/4"	1"		
54P-5B-16-08	BSPM X BSPF-16-08 FIXED REDUCER	1"	1/2"		
54P-5B-16-12	BSPM X BSPF-16-12 FIXED REDUCER	1"	3/4"		
54P-5B-16	BSPM X BSPF-16-16 FIXED REDUCER	1"	1"		
54P-5B-16-20	BSPM X BSPF-16-20 FIXED REDUCER	1"	1 1/4"		
54P-5B-20-16	BSPM X BSPF-20-16 FIXED REDUCER	1 1/4"	1"		
54P-5B-20	BSPM X BSPF-20-20 FIXED REDUCER	1 1/4"	1 1/4"		
54P-5B-20-24	BSPM X BSPF-20-24 FIXED REDUCER	1 1/4"	1 1/2"		
54P-5B-24-16	BSPM X BSPF-24-16 FIXED REDUCER	1 1/2"	1"		

BSP MALE X BSP FEMALE FIXED LONG EXTENSION

Part No	Description	Size	Size	Visual	Retail
54P-5BL-02	BSPM X BSPF-02-02 FIXED LONG EXTENSION	1/8"	1/8"		
54P-5BL-04	BSPM X BSPF-04-04 FIXED LONG EXTENSION	1/4"	1/4"		
54P-5BL-06	BSPM X BSPF-06-06 FIXED LONG EXTENSION	3/8"	3/8"		
54P-5BL-08	BSPM X BSPF-08-08 FIXED LONG EXTENSION	1/2"	1/2"		
54P-5BL-10	BSPM X BSPF-10-10 FIXED LONG EXTENSION	5/8"	5/8"		
54P-5BL-12	BSPM X BSPF-12-12 FIXED LONG EXTENSION	3/4"	3/4"		
54P-5BL-16	BSPM X BSPF-16-16 FIXED LONG EXTENSION	1"	1"		

MALE/FEMALE REDUCING BUSH

Part No	Description	Size	Size	Visual	Retail
54P-5BS-06-04	BSPP 3/8" - 1/4" M/F REDUCING BUSH	3/8"	1/4"		
54P-5BS-08-04	BSPP 1/2" - 1/4" M/F REDUCING BUSH	1/2"	1/4"		
54P-5BS-08-06	BSPP 1/2" - 3/8" M/F REDUCING BUSH	1/2"	3/8"		
54P-5BS-12-04	BSPP 3/4" - 1/4" M/F REDUCING BUSH	3/4"	1/4"		
54P-5BS-12-06	BSPP 3/4" - 3/8" M/F REDUCING BUSH	3/4"	3/8"		
54P-5BS-12-08	BSPP 3/4" - 1/2" M/F REDUCING BUSH	3/4"	1/2"		
54P-5BS-16-08	BSPP 1" - 1/2" M/F REDUCING BUSH	1"	1/2"		
54P-5BS-16-12	BSPP 1" - 3/4" M/F REDUCING BUSH	1"	3/4"		
54P-5BS-20-12	BSPP 1 1/4" - 3/4" M/F REDUCING BUSH	1 1/4"	1"		
54P-5BS-20-16	BSPP 1 1/4" - 1" M/F REDUCING BUSH	1 1/4"	1"		
54P-5BS-24-16	BSPP 1 1/2" - 1" M/F REDUCING BUSH	1 1/2"	1"		

B.S.P. ADAPTORS

Retail

Prices

BSP MALE X BSP MALE BULKHEAD WITH LOCKNUT

19-07-2023

Part No	Description	Bspm	Bspm	Visual	Retail
54P-6B-LN-04	BSPM X BULKHEAD-04 BHB-04	1/4"	1/4"		
54P-6B-LN-06	BSPM X BULKHEAD-06 BHB-06	3/8"	3/8"		
54P-6B-LN-08	BSPM X BULKHEAD-08 BHB-08	1/2"	1/2"		
54P-6B-LN-10	BSPM X BULKHEAD-10 BHB-10	5/8"	5/8"		
54P-6B-LN-12	BSPM X BULKHEAD-12 BHB-12	3/4"	3/4"		
54P-6B-LN-16	BSPM X BULKHEAD-16 BHB-16	1"	1"		
54P-6B-LN-20	BSPM X BULKHEAD-20 BHB-20	1 1/4"	1 1/4"		

BSP MALE X BSP MALE 90° BULKHEAD WITH LOCKNUT

Part No	Description	Bspm	Bspm	Visual	Retail
54P-6B9-LN-04	BSPM X BULKHEAD-90-04 BHB-90-04	1/4"	1/4"		
54P-6B9-LN-06	BSPM X BULKHEAD-90-06 BHB-90-06	3/8"	3/8"		
54P-6B9-LN-08	BSPM X BULKHEAD-90-08 BHB-90-08	1/2"	1/2"		
54P-6B9-LN-10	BSPM X BULKHEAD-90-10 BHB-90-10	5/8"	5/8"		
54P-6B9-LN-12	BSPM X BULKHEAD-90-12 BHB-90-12	3/4"	3/4"		
54P-6B9-LN-16	BSPM X BULKHEAD-90-16 BHB-90-16	1"	1"		
54P-6B9-LN-20	BSPM X BULKHEAD-90-20 BHB-90-20	1 1/4"	1 1/4"		

BSP BULKHEAD LOCKNUT

Part No	Description	Bspm	Visual	Retail
54P-8B-04	BSPM X BULKHEAD LOCKNUT-04	1/4"		
54P-8B-06	BSPM X BULKHEAD LOCKNUT-06	3/8"		
54P-8B-08	BSPM X BULKHEAD LOCKNUT-08	1/2"		
54P-8B-10	BSPM X BULKHEAD LOCKNUT-10	5/8"		
54P-8B-12	BSPM X BULKHEAD LOCKNUT-12	3/4"		
54P-8B-16	BSPM X BULKHEAD LOCKNUT-16	1"		
54P-8B-20	BSPM X BULKHEAD LOCKNUT-20	1 1/4"		

BSP FIXED FEMALE SOCKET

Part No	Description	Bspf	Visual	Retail
54P-7B-02	BSPF X SOCKET-02	1/8"		
54P-7B-04	BSPF X SOCKET-04	1/4"		
54P-7B-06	BSPF X SOCKET-06	3/8"		
54P-7B-08	BSPF X SOCKET-08	1/2"		
54P-7B-10	BSPF X SOCKET-10	5/8"		
54P-7B-12	BSPF X SOCKET-12	3/4"		
54P-7B-16	BSPF X SOCKET-16	1"		
54P-7B-20	BSPF X SOCKET-20	1 1/4"		
54P-7B-24	BSPF X SOCKET-24	1 1/2"		

BSP FIXED FEMALE SOCKET 90°

Part No	Description	Bspf	Visual	Retail
54P-7B9-02	BSPF X SOCKET-90-02	1/8"		
54P-7B9-04	BSPF X SOCKET-90-04	1/4"		
54P-7B9-06	BSPF X SOCKET-90-06	3/8"		
54P-7B9-08	BSPF X SOCKET-90-08	1/2"		
54P-7B9-12	BSPF X SOCKET-90-12	3/4"		
54P-7B9-16	BSPF X SOCKET-90-16	1"		
54P-7B9-20	BSPF X SOCKET-90-20	1 1/4"		
54P-7B9-24	BSPF X SOCKET-90-24	1 1/2"		

B.S.P. ADAPTORS

Retail
Prices
04-04-2023

BSP FEMALE CONE PLUG

Part No	Description	size	size	size	Visual	Retail
54P-9B-04	BSPF X HEX CAP-04 304B-04	1/4"				
54P-9B-06	BSPF X HEX CAP-06 304B-06	3/8"				
54P-9B-08	BSPF X HEX CAP-08 304B-08	1/2"				
54P-9B-10	BSPF X HEX CAP-10 304B-10	5/8"				
54P-9B-12	BSPF X HEX CAP-12 304B-12	3/4"				
54P-9B-16	BSPF X HEX CAP-16 304B-16	1"				

BSP MALE TEE

Part No	Description	size	size	size	Visual	Retail
54P-AB-02	BSPM X BSPM X BSPM-02-02-02 FIXED	1/8"	1/8"	1/8"		
54P-AB-04	BSPM X BSPM X BSPM-04-04-04 FIXED	1/4"	1/4"	1/4"		
54P-AB-04-06-04	BSPM X BSPM X BSPM-04-06-04 FIXED	1/4"	3/8"	1/4"		
54P-AB-06-04-06	BSPM X BSPM X BSPM-06-04-06 FIXED	3/8"	1/4"	3/8"		
54P-AB-06	BSPM X BSPM X BSPM-06-06-06 FIXED	3/8"	3/8"	3/8"		
54P-AB-06-08-06	BSPM X BSPM X BSPM-06-08-06 FIXED	3/8"	1/2"	3/8"		
54P-AB-08-06-08	BSPM X BSPM X BSPM-06-08-06 FIXED	1/2"	3/8"	1/2"		
54P-AB-08	BSPM X BSPM X BSPM-08-08-08 FIXED	1/2"	1/2"	1/2"		
54P-AB-10	BSPM X BSPM X BSPM-10-10-10 FIXED	5/8"	5/8"	5/8"		
54P-AB-12	BSPM X BSPM X BSPM-12-12-12 FIXED	3/4"	3/4"	3/4"		
54P-AB-12-16-12	BSPM X BSPM X BSPM-12-16-12 FIXED	3/4"	1"	3/4"		
54P-AB-16-12-16	BSPM X BSPM X BSPM-16-12-16 FIXED	1"	3/4"	1"		
54P-AB-16	BSPM X BSPM X BSPM-16-16-16 FIXED	1"	1"	1"		
54P-AB-20	BSPM X BSPM X BSPM-20-20-20 FIXED	1 1/4"	2 1/4"	3 1/4"		
54P-AB-24	BSPM X BSPM X BSPM-24-24-24 FIXED	1 1/2"	2 1/2"	3 1/2"		
54P-AB-32	BSPM X BSPM X BSPM-32-32-32 FIXED	2"	2"	2"		

BSP FEMALE SWIVEL TEE

Part No	Description	size	size	size	Visual	Retail
54P-DB-02	BSPF X BSPF X BSPF-02-02-02 SWIVEL	1/8"	1/8"	1/8"		
54P-DB-04	BSPF X BSPF X BSPF-04-04-04 SWIVEL	1/4"	1/4"	1/4"		
54P-DB-06	BSPF X BSPF X BSPF-06-06-06 SWIVEL	3/8"	3/8"	3/8"		
54P-DB-08	BSPF X BSPF X BSPF-08-08-08 SWIVEL	1/2"	1/2"	1/2"		
54P-DB-10	BSPF X BSPF X BSPF-10-10-10 SWIVEL	5/8"	5/8"	5/8"		
54P-DB-12	BSPF X BSPF X BSPF-12-12-12 SWIVEL	3/4"	3/4"	3/4"		
54P-DB-16	BSPF X BSPF X BSPF-16-16-16 SWIVEL	1"	1"	1"		
54P-DB-20	BSPF X BSPF X BSPF-20-20-20 SWIVEL	1 1/4"	1 1/4"	1 1/4"		
54P-DB-24	BSPF X BSPF X BSPF-24-24-24 SWIVEL	1 1/2"	1 1/2"	1 1/2"		

BSP FEMALE FIXED TEE

Part No	Description	size	size	size	Visual	Retail
54P-GB-02	BSPF X BSPF X BSPF-02-02-02 FIXED	1/8"	1/8"	1/8"		
54P-GB-04	BSPF X BSPF X BSPF-04-04-04 FIXED	1/4"	1/4"	1/4"		
54P-GB-06	BSPF X BSPF X BSPF-06-06-06 FIXED	3/8"	3/8"	3/8"		
54P-GB-08	BSPF X BSPF X BSPF-08-08-08 FIXED	1/2"	1/2"	1/2"		
54P-GB-12	BSPF X BSPF X BSPF-12-12-12 FIXED	3/4"	3/4"	3/4"		
54P-GB-16	BSPF X BSPF X BSPF-16-16-16 FIXED	1"	1"	1"		
54P-GB-20	BSPF X BSPF X BSPF-20-20-20 FIXED	1 1/4"	1 1/4"	1 1/4"		
54P-GB-24	BSPF X BSPF X BSPF-24-24-24 FIXED	1 1/2"	1 1/2"	1 1/2"		

N.P.T ADAPTORS

Retail

Prices

NPT MALE X NPT FEMALE SWIVEL

30-03-2023

Part No	Description	Npt	Npt	Visual	Retail
54P-2NU-02	NPTM X NPTF-02-02 1404-02-02	1/8"	1/8"		
54P-2NU-02-04	NPTM X NPTF-02-04 1404-02-04	1/8"	1/4"		
54P-2NU-04-02	NPTM X NPTF-04-02 1404-04-02	1/4"	1/8"		
54P-2NU-04	NPTM X NPTF-04-04 1404-04-04	1/4"	1/4"		
54P-2NU-04-06	NPTM X NPTF-04-06 1404-04-06	1/4"	3/8"		
54P-2NU-06-04	NPTM X NPTF-06-04 1404-06-04	3/8"	1/4"		
54P-2NU-06	NPTM X NPTF-06-06 1404-06-06	3/8"	3/8"		
54P-2NU-06-08	NPTM X NPTF-06-08 1404-06-08	3/8"	1/2"		
54P-2NU-08-04	NPTM X NPTF-08-04 1404-08-04	1/2"	1/4"		
54P-2NU-08-06	NPTM X NPTF-08-06 1404-08-06	1/2"	3/8"		
54P-2NU-08	NPTM X NPTF-08-08 1404-08-08	1/2"	1/2"		
54P-2NU-08-12	NPTM X NPTF-08-12 1404-08-12	1/2"	3/4"		
54P-2NU-12-08	NPTM X NPTF-12-08 1404-12-08	3/4"	1/2"		
54P-2NU-12	NPTM X NPTF-12-12 1404-12-12	3/4"	3/4"		
54P-2NU-12-16	NPTM X NPTF-12-16 1404-12-16	3/4"	1"		
54P-2NU-16-12	NPTM X NPTF-16-12 1404-16-12	1"	3/4"		
54P-2NU-16	NPTM X NPTF-16-16 1404-16-16	1"	1"		
54P-2NU-16-20	NPTM X NPTF-16-20 1404-16-20	1"	1 1/4"		
54P-2NU-20	NPTM X NPTF-20-20 1404-20-20	1 1/4"	1 1/4"		
54P-2NU-20-24	NPTM X NPTF-20-24 1404-20-24	1 1/4"	1 1/2"		
54P-2NU-24	NPTM X NPTF-24-24 1404-24-24	1 1/2 "	1 1/2"		
54P-2NU-32	NPTM X NPTF-32-32 1404-32-32	2"	2"		

NPT MALE X NPT FEMALE SWIVEL 45°

Part No	Description	Npt	Npt	Visual	Retail
54P-2NU4-02	NPTM X NPTF-45-02-02 1503-02-02	1/8"	1/8"		
54P-2NU4-04-02	NPTM X NPTF-45-04-02 1503-04-02	1/4"	1/8"		
54P-2NU4-04	NPTM X NPTF-45-04-04 1503-04-04	1/4"	1/4"		
54P-2NU4-06	NPTM X NPTF-45-06-06 1503-06-06	3/8"	3/8"		
54P-2NU4-08-06	NPTM X NPTF-45-08-06 1503-08-06	1/2"	3/8"		
54P-2NU4-08	NPTM X NPTF-45-08-08 1503-08-08	1/2"	1/2"		
54P-2NU4-12-08	NPTM X NPTF-45-12-08 1503-12-08	3/4"	1/2"		
54P-2NU4-12	NPTM X NPTF-45-12-12 1503-12-12	3/4"	3/4"		
54P-2NU4-16-12	NPTM X NPTF-45-16-12 1503-16-12	1"	3/4"		
54P-2NU4-16	NPTM X NPTF-45-16-16 1503-16-16	1"	1"		
54P-2NU4-20	NPTM X NPTF-45-20-20 1503-20-20	1 1/4"	1 1/4"		
54P-2NU4-24	NPTM X NPTF-45-24-24 1503-24-24	1 1/2 "	1 1/2"		
54P-2NU4-32	NPTM X NPTF-45-32-32 1503-32-32	2"	2"		

NPT MALE X NPT FEMALE SWIVEL 90°

Part No	Description	Npt	Npt	Visual	Retail
54P-2NU9-02	NPTM X NPTF-90-02-02 1501-02-02	1/8"	1/8"		
54P-2NU9-02-04	NPTM X NPTF-90-02-04 1501-02-04	1/8"	1/4"		
54P-2NU9-04-02	NPTM X NPTF-90-04-02 1501-04-02	1/4"	1/8"		
54P-2NU9-04	NPTM X NPTF-90-04-04 1501-04-04	1/4"	1/4"		
54P-2NU9-04-06	NPTM X NPTF-90-04-06 1501-04-06	1/4"	3/8"		
54P-2NU9-06-04	NPTM X NPTF-90-06-04 1501-06-04	3/8"	1/4"		
54P-2NU9-06	NPTM X NPTF-90-06-06 1501-06-06	3/8"	3/8"		
54P-2NU9-06-08	NPTM X NPTF-90-06-08 1501-06-08	3/8"	1/2"		
54P-2NU9-08-06	NPTM X NPTF-90-08-06 1501-08-06	1/2"	3/8"		
54P-2NU9-08	NPTM X NPTF-90-08-08 1501-08-08	1/2"	1/2"		
54P-2NU9-08-12	NPTM X NPTF-90-08-12 1501-08-12	1/2"	3/4"		
54P-2NU9-12-08	NPTM X NPTF-90-12-08 1501-12-08	3/4"	1/2"		
54P-2NU9-12	NPTM X NPTF-90-12-12 1501-12-12	3/4"	3/4"		
54P-2NU9-12-16	NPTM X NPTF-90-12-16 1501-12-16	3/4"	1"		
54P-2NU9-16-12	NPTM X NPTF-90-16-12 1501-16-12	1"	3/4"		
54P-2NU9-16	NPTM X NPTF-90-16-16 1501-16-16	1"	1"		
54P-2NU9-16-20	NPTM X NPTF-90-16-20 1501-16-20	1"	1 1/4"		
54P-2NU9-20	NPTM X NPTF-90-20-20 1501-20-20	1 1/4"	1 1/4"		
54P-2NU9-24	NPTM X NPTF-90-24-24 1501-24-24	1 1/2 "	1 1/2"		
54P-2NU9-32	NPTM X NPTF-90-32-32 1501-32-32	2"	2"		

NPT ADAPTORS

Retail

Prices

NPT MALE X NPT FEMALE FIXED ELBOW 90°

19-07-2023

Part No	Description	Npt	Npt	Visual	Retail
54P-5N9-02	NPTM X NPTF-90-02-02 5502-02-02	1/8"	1/8"		
54P-5N9-04	NPTM X NPTF-90-04-04 5502-04-04	1/4"	1/4"		
54P-5N9-06	NPTM X NPTF-90-04-05 5502-06-06	3/8"	3/8"		
54P-5N9-08	NPTM X NPTF-90-04-06 5502-08-08	1/2"	1/2"		
54P-5N9-12	NPTM X NPTF-90-04-07 5502-12-12	3/4"	3/4"		
54P-5N9-16	NPTM X NPTF-90-04-08 5502-16-16	1"	1"		
54P-5N9-20	NPTM X NPTF-90-04-09 5502-20-20	1 1/4"	1 1/4"		
54P-5N9-24	NPTM X NPTF-90-04-10 5502-24-24	1 1/2"	1 1/2"		
54P-5N9-32	NPTM X NPTF-90-04-11 5502-32-32	2"	2"		

NPT SOCKET X STRAIGHT

Part No	Description	Npt	Npt	Visual	Retail
54P-7N-02	NPTF X NPTF-02-02 5000-02-02	1/8"	1/8"		
54P-7N-02-04	NPTF X NPTF-02-04 5000-02-04	1/8"	1/4"		
54P-7N-04-04	NPTF X NPTF-04-04 5000-04-04	1/4"	1/4"		
54P-7N-04-06	NPTF X NPTF-04-06 5000-04-06	1/4"	3/8"		
54P-7N-04-08	NPTF X NPTF-04-08 5000-04-08	1/4"	1/2"		
54P-7N-06-06	NPTF X NPTF-06-06 5000-06-06	3/8"	3/8"		
54P-7N-06-08	NPTF X NPTF-06-08 5000-06-08	3/8"	1/2"		
54P-7N-08-08	NPTF X NPTF-08-08 5000-08-08	1/2"	1/2"		
54P-7N-08-12	NPTF X NPTF-08-12 5000-08-12	1/2"	3/4"		
54P-7N-08-16	NPTF X NPTF-08-16 5000-08-16	1/2"	1"		
54P-7N-12-12	NPTF X NPTF-12-12 5000-12-12	3/4"	3/4"		
54P-7N-12-16	NPTF X NPTF-12-16 5000-12-16	3/4"	1"		
54P-7N-16	NPTF X NPTF-16-16 5000-16-16	1"	1"		
54P-7N-20	NPTF X NPTF-20-20 5000-20-20	1 1/4"	1 1/4"		
54P-7N-24	NPTF X NPTF-24-24 5000-24-24	1 1/2"	1 1/2"		
54P-7N-32	NPTF X NPTF-32-32 5000-32-32	2"	2"		

NPT SOCKETS 90°

Part No	Description	Npt	Npt	Visual	Retail
54P-7N9-02	NPTF X NPTF-90-02-02 5504-02-02	1/8"	1/8"		
54P-7N9-04	NPTF X NPTF-90-04-04 5504-04-04	1/4"	1/4"		
54P-7N9-06	NPTF X NPTF-90-06-06 5504-06-06	3/8"	3/8"		
54P-7N9-08	NPTF X NPTF-90-08-08 5504-08-08	1/2"	1/2"		
54P-7N9-12	NPTF X NPTF-90-12-12 5504-12-12	3/4"	3/4"		
54P-7N9-16	NPTF X NPTF-90-16-16 5504-16-16	1"	1"		
54P-7N9-20	NPTF X NPTF-90-20-20 5504-20-20	1 1/4"	1 1/4"		
54P-7N9-24	NPTF X NPTF-90-24-24 5504-24-24	1 1/2"	1 1/2"		
54P-7N9-32	NPTF X NPTF-90-32-32 5504-32-32	2"	2"		

NPT FEMALE SWIVEL X NPT FEMALE FIXED

Part No	Description	Npt	Npt	Visual	Retail
54P-7NU-S-02	NPTF X NPTF-02-02 SWIVEL / FIXED	1/8"	1/8"		
54P-7NU-S-04	NPTF X NPTF-04-04 SWIVEL / FIXED	1/4"	1/4"		
54P-7NU-S-06	NPTF X NPTF-06-06 SWIVEL / FIXED	3/8"	3/8"		
54P-7NU-S-06-08	NPTF X NPTF-06-08 SWIVEL / FIXED	3/8"	1/2"		
54P-7NU-S-08	NPTF X NPTF-08-08 SWIVEL / FIXED	1/2"	1/2"		
54P-7NU-S-12	NPTF X NPTF-12-12 SWIVEL / FIXED	3/4"	3/4"		
54P-7NU-S-16	NPTF X NPTF-16-16 SWIVEL / FIXED	1"	1"		
54P-7NU-S-20	NPTF X NPTF-20-20 SWIVEL / FIXED	1 1/4"	1 1/4"		

NPT FEMALE FIXED X NPT FEMALE SWIVEL 90°

Part No	Description	Npt	Npt	Visual	Retail
54P-7NU9-04	1/4 NPT F FIX X 1/4 NPT F SWIV 90°	1/4"	1/4"		
54P-7NU9-06	3/8 NPT F FIX X 3/8 NPT F SWIV 90°	3/8"	3/8"		
54P-7NU9-08	1/2 NPT F FIX X 1/2 NPT F SWIV 90°	1/2"	1/2"		
54P-7NU9-12	3/4 NPT F FIX X 3/4 NPT F SWIV 90°	3/4"	3/4"		

J.I.C. ADAPTORS

Retail

Prices

JIC MALE X JIC MALE

19-09-2023

Part No	Description	Jic	Jic	Visual	Retail
54P-1J-04	JICM X JICM-04-04 2403-04-04	7/16"	7/16"		
54P-1J-04-05	JICM X JICM-05-04 2403-05-04	1/2"	7/16"		
54P-1J-05	JICM X JICM-05-05 2403-05-05	1/2"	1/2"		
54P-1J-04-06	JICM X JICM-06-04 2403-06-04	9/16"	7/16"		
54P-1J-05-06	JICM X JICM-06-05 2403-06-05	9/16"	1/2"		
54P-1J-06	JICM X JICM-06-06 2403-06-06	9/16"	9/16"		
54P-1J-06-08	JICM X JICM-08-06 2403-08-06	3/4"	9/16"		
54P-1J-08	JICM X JICM-08-08 2403-08-08	3/4"	3/4"		
54P-1J-08-10	JICM X JICM-10-08 2403-10-08	7/8"	3/4"		
54P-1J-10	JICM X JICM-10-10 2403-10-10	7/8"	7/8"		
54P-1J-08-12	JICM X JICM-12-08 2403-12-08	1 1/16"	3/4"		
54P-1J-10-12	JICM X JICM-12-10 2403-12-10	7/8"	1 1/16"		
54P-1J-12	JICM X JICM-12-12 2403-12-12	1 1/16"	1 1/16"		
54P-1J-12-16	JICM X JICM-16-12 2403-16-12	1 5/16"	1 1/16"		
54P-1J-16	JICM X JICM-16-16 2403-16-16	1 5/16"	1 5/16"		
54P-1J-16-20	JICM X JICM-20-16 2403-20-16	1 5/8"	1 5/16"		
54P-1J-20	JICM X JICM-20-20 2403-20-20	1 5/8"	1 5/8"		
54P-1J-24	JICM X JICM-24-24 2403-24-24	1 7/8"	1 7/8"		
54P-1J-32	JICM X JICM-32-32 2403-32-32	2 1/2"	2 1/2"		

JIC MALE X JIC MALE 45°

Part No	Description	Jic	Jic	Visual	Retail
54P-1J4-04-04	JICM X JICM-45-04-04 2504-04-04	7/16"	7/16"		
54P-1J4-05-05	JICM X JICM-45-05-05 2504-05-05	1/2"	1/2"		
54P-1J4-06-06	JICM X JICM-45-06-06 2504-06-06	9/16"	9/16"		
54P-1J4-08-08	JICM X JICM-45-08-08 2504-08-08	3/4"	3/4"		
54P-1J4-10-10	JICM X JICM-45-10-10 2504-10-10	7/8"	7/8"		
54P-1J4-12-12	JICM X JICM-45-12-12 2504-12-12	1 1/16"	1 1/16"		
54P-1J4-16-16	JICM X JICM-45-16-16 2504-16-16	1 5/16"	1 5/16"		
54P-1J4-20-20	JICM X JICM-45-20-20 2504-20-20	1 5/8"	1 5/8"		

JIC MALE X JIC MALE 90°

Part No	Description	Jic	Jic	Visual	Retail
54P-1J9-04-04	JICM X JICM-90-04-04 2500-04-04	7/16"	7/16"		
54P-1J9-05-05	JICM X JICM-90-05-05 2500-05-05	1/2"	1/2"		
54P-1J9-06-06	JICM X JICM-90-06-06 2500-06-06	9/16"	9/16"		
54P-1J9-08-08	JICM X JICM-90-08-08 2500-08-08	3/4"	3/4"		
54P-1J9-10-10	JICM X JICM-90-10-10 2500-10-10	7/8"	7/8"		
54P-1J9-12-12	JICM X JICM-90-12-12 2500-12-12	1 1/16"	1 1/16"		
54P-1J9-16-16	JICM X JICM-90-16-16 2500-16-16	1 5/16"	1 5/16"		
54P-1J9-20-20	JICM X JICM-90-20-20 2500-20-20	1 5/8"	1 5/8"		

JIC MALE X SAE O RING FLANGE STRAIGHT 3000 PSI

Part No	Description	Jic	Sae	Visual	Retail
54P-1JFL-12-12	JICM X SAE-O RING-FLANGE-12-12	1 1/16"	1 1/16"		
54P-1JFL-12-16	JICM X SAE-O RING-FLANGE-12-16	1 1/16"	1 5/16"		
54P-1JFL-16-16	JICM X SAE-O RING-FLANGE-16-16	1 5/16"	1 5/16"		
54P-1JFL-20-20	JICM X SAE-O RING-FLANGE-20-20	1 5/8"	1 5/8"		
54P-1JFL-24-24	JICM X SAE-O RING-FLANGE-24-24	1 7/8"	1 7/8"		

JIC MALE X SAE FLANGE MALE 45° 3000 PSI

Part No	Description	Jic	Sae	Visual	Retail
54P-1JFL4-12-16	JICM X SAE-O RING-FLANGE-45-12-16	1 1/16"	1 5/16"		
54P-1JFL4-16-16	JICM X SAE-O RING-FLANGE-45-16-16	1 5/16"	1 5/16"		
54P-1JFL4-20-20	JICM X SAE-O RING-FLANGE-45-20-20	1 5/8"	1 5/8"		
54P-1JFL4-24-24	JICM X SAE-O RING-FLANGE-45-24-24	1 7/8"	1 7/8"		

J.I.C. ADAPTORS

Retail

Prices

JIC MALE X SAE O RING FLANGE 90° 3000 PSI

19-07-2023

Part No	Description	Jic	Sae	Visual	Retail
54P-1JFL9-12-12	JICM X SAE-O RING-FLANGE-90-12-12	1 1/16"	1 1/16"		
54P-1JFL9-12-16	JICM X SAE-O RING-FLANGE-90-12-16	1 1/16"	1 5/16"		
54P-1JFL9-16-16	JICM X SAE-O RING-FLANGE-90-16-16	1 5/16"	1 5/16"		
54P-1JFL9-20-16	JICM X SAE-O RING-FLANGE-90-20-16	1 5/8"	1 5/16"		
54P-1JFL9-20-20	JICM X SAE-O RING-FLANGE-90-20-20	1 5/8"	1 5/8"		
54P-1JFL9-24-24	JICM X SAE-O RING-FLANGE-90-24-24	1 7/8"	1 7/8"		

JIC MALE X SAE FLANGE STRAIGHT 6000 PSI

Part No	Description	Jic	Sae	Visual	Retail
54P-1JFS-12-12	JICM X SAE-O RING-FLANGE-12-12	1 1/16"	1 1/16"		
54P-1JFS-16-16	JICM X SAE-O RING-FLANGE-16-16	1 5/16"	1 5/16"		
54P-1JFS-20-20	JICM X SAE-O RING-FLANGE-20-20	1 5/8"	1 5/8"		
54P-1JFS-24-24	JICM X SAE-O RING-FLANGE-24-24	1 7/8"	1 7/8"		

JIC MALE X SAE FLANGE 45° 6000 PSI

Part No	Description	Jic	Sae	Visual	Retail
54P-1JFS4-20-20	JICM X SAE-O RING-FLANGE-45-20-20	1 5/8"	1 5/8"		
54P-1JFS4-24-24	JICM X SAE-O RING-FLANGE-45-24-24	1 7/8"	1 7/8"		

JIC MALE X SAE FLANGE 90° 6000 PSI

Part No	Description	Jic	Sae	Visual	Retail
54P-1JFS9-12-12	JICM X SAE-O RING-FLANGE-90-12-12	1 1/16"	1 1/16"		
54P-1JFS9-16-16	JICM X SAE-O RING-FLANGE-90-16-16	1 5/16"	1 5/16"		
54P-1JFS9-20-20	JICM X SAE-O RING-FLANGE-90-20-20	1 5/8"	1 5/8"		
54P-1JFS9-24-24	JICM X SAE-O RING-FLANGE-90-24-24	1 7/8"	1 7/8"		

JIC MALE X BSP MALE SWIVEL 90° ELBOW

Part No	Description	Jic	Bsp	Visual	Retail
54P-1JG9-OG0402	JICM X BSPM-90-04-02 C40XS-04-02	7/16"	1/8"		
54P-1JG9-OG-04	JICM X BSPM-90-04-04 C40XS-04-04	7/16"	1/4"		
54P-1JG9-OG0406	JICM X BSPM-90-04-06 C40XS-04-06	7/16"	3/8"		
54P-1JG9-OG0604	JICM X BSPM-90-06-04 C40XS-06-04	9/16"	1/4"		
54P-1JG9-OG-06	JICM X BSPM-90-06-06 C40XS-06-06	9/16"	3/8"		
54P-1JG9-OG0608	JICM X BSPM-90-06-08 C40XS-06-08	9/16"	1/2"		
54P-1JG9-OG0806	JICM X BSPM-90-08-06 C40XS-08-06	3/4"	3/8"		
54P-1JG9-OG-08	JICM X BSPM-90-08-08 C40XS-08-08	3/4"	1/2"		
54P-1JG9-OG0812	JICM X BSPM-90-08-12 C40XS-08-12	3/4"	3/4"		
54P-1JG9-OG1008	JICM X BSPM-90-10-08 C40XS-10-08	7/8"	1/2"		
54P-1JG9-OG-10	JICM X BSPM-90-10-10 C40XS-10-10	7/8"	5/8"		
54P-1JG9-OG1012	JICM X BSPM-90-10-12 C40XS-10-12	7/8"	3/4"		
54P-1JG9-OG1208	JICM X BSPM-90-12-08 C40XS-12-08	1 1/16"	1/2"		
54P-1JG9-OG-12	JICM X BSPM-90-12-12 C40XS-12-12	1 1/16"	3/4"		
54P-1JG9-OG1216	JICM X BSPM-90-12-16 C40XS-12-16	1 1/16"	1"		
54P-1JG9-OG1612	JICM X BSPM-90-16-12 C40XS-16-12	1 5/16"	3/4"		
54P-1JG9-OG-16	JICM X BSPM-90-16-16 C40XS-16-16	1 5/16"	1"		
54P-1JG9-OG-20	JICM X BSPM-90-20-20 C40XS-20-20	1 5/8"	1 1/4"		
54P-1JG9-OG-24	JICM X BSPM-90-24-24 C40XS-24-24	1 7/8"	1 1/2"		

J.I.C. ADAPTORS

Retail

Prices

JIC MALE X METRIC MALE STRAIGHT

19-07-2023

Part No	Description	Jic	Metric	Visual	Retail
54P-1JH-04-12	JICM X METM-04-12MM 4JM-12MM	7/16"	12mm		
54P-1JH-04-14	JICM X METM-04-14MM 4JM-14MM	7/16"	14mm		
54P-1JH-05-12	JICM X METM-05-12MM 5JM-12MM	1/2"	12mm		
54P-1JH-05-14	JICM X METM-05-14MM 5JM-14MM	1/2"	14mm		
54P-1JH-06-12	JICM X METM-06-12MM 6JM-12MM	9/16"	12mm		
54P-1JH-06-14	JICM X METM-06-14MM 6JM-14MM	9/16"	14mm		
54P-1JH-06-16	JICM X METM-06-16MM 6JM-16MM	9/16"	16mm		
54P-1JH-06-18	JICM X METM-06-18MM 6JM-18MM	9/16"	18mm		
54P-1JH-08-14	JICM X METM-08-14MM 8JM-14MM	3/4"	14mm		
54P-1JH-08-16	JICM X METM-08-16MM 8JM-16MM	3/4"	16mm		
54P-1JH-08-18	JICM X METM-08-18MM 8JM-18MM	3/4"	18mm		
54P-1JH-08-22	JICM X METM-08-22MM 8JM-22MM	3/4"	22mm		
54P-1JH-10-18	JICM X METM-10-18MM 10JM-18MM	7/8"	18mm		
54P-1JH-12-18	JICM X METM-12-18MM 12JM-18MM	1 1/16"	18mm		
54P-1JH-12-22	JICM X METM-12-22MM 12JM-22MM	1 1/16"	22mm		

JIC MALE X NPT MALE STRAIGHT

Part No	Description	Jic	Npt	Visual	Retail
54P-1JN-04-02	JICM X NPTM-04-02 2404-04-02	7/16"	1/8"		
54P-1JN-04-04	JICM X NPTM-04-04 2404-04-04	7/16"	1/4"		
54P-1JN-04-06	JICM X NPTM-04-06 2404-04-06	7/16"	3/8"		
54P-1JN-04-08	JICM X NPTM-04-08 2404-04-08	7/16"	1/2"		
54P-1JN-05-02	JICM X NPTM-05-02 2404-05-02	1/2"	1/8"		
54P-1JN-05-04	JICM X NPTM-05-04 2404-05-04	1/2"	1/4"		
54P-1JN-05-06	JICM X NPTM-05-06 2404-05-06	1/2"	3/8"		
54P-1JN-06-02	JICM X NPTM-06-02 2404-06-02	9/16"	1/8"		
54P-1JN-06-04	JICM X NPTM-06-04 2404-06-04	9/16"	1/4"		
54P-1JN-06-06	JICM X NPTM-06-06 2404-06-06	9/16"	3/8"		
54P-1JN-06-08	JICM X NPTM-06-08 2404-06-08	9/16"	1/2"		
54P-1JN-06-12	JICM X NPTM-06-12 2404-06-12	9/16"	3/4"		
54P-1JN-08-04	JICM X NPTM-08-04 2404-08-04	3/4"	1/4"		
54P-1JN-08-06	JICM X NPTM-08-06 2404-08-06	3/4"	3/8"		
54P-1JN-08-08	JICM X NPTM-08-08 2404-08-08	3/4"	1/2"		
54P-1JN-08-12	JICM X NPTM-08-12 2404-08-12	3/4"	3/4"		
54P-1JN-08-16	JICM X NPTM-08-16 2404-08-16	3/4"	1"		
54P-1JN-10-06	JICM X NPTM-10-06 2404-10-06	7/8"	3/8"		
54P-1JN-10-08	JICM X NPTM-10-08 2404-10-08	7/8"	1/2"		
54P-1JN-10-12	JICM X NPTM-10-12 2404-10-12	7/8"	3/4"		
54P-1JN-12-06	JICM X NPTM-12-06 2404-12-06	1 1/16"	3/8"		
54P-1JN-12-08	JICM X NPTM-12-08 2404-12-08	1 1/16"	1/2"		
54P-1JN-12-12	JICM X NPTM-12-12 2404-12-12	1 1/16"	3/4"		
54P-1JN-12-16	JICM X NPTM-12-16 2404-12-16	1 1/16"	1"		
54P-1JN-12-20	JICM X NPTM-12-20 2404-12-20	1 1/16"	1 1/4"		
54P-1JN-16-12	JICM X NPTM-16-12 2404-16-12	1 5/16"	3/4"		
54P-1JN-16-16	JICM X NPTM-16-16 2404-16-16	1 5/16"	1"		
54P-1JN-16-20	JICM X NPTM-16-20 2404-16-20	1 5/16"	1 1/4"		
54P-1JN-20-16	JICM X NPTM-20-16 2404-20-16	1 5/8"	1"		
54P-1JN-20-20	JICM X NPTM-20-20 2404-20-20	1 5/8"	1 1/4"		
54P-1JN-20-24	JICM X NPTM-20-24 2404-20-24	1 5/8"	1 1/2"		
54P-1JN-24-20	JICM X NPTM-24-20 2404-24-20	1 7/8"	1 1/4"		
54P-1JN-24-24	JICM X NPTM-24-24 2404-24-24	1 7/8"	1 1/2"		
54P-1JN-32-32	JICM X NPTM-32-32 2404-32-32	2 1/2"	2"		

J.I.C. ADAPTORS

Retail

Prices

JIC MALE X NPT MALE 45°

19-07-2023

Part No	Description	Jic	Npt	Visual	Retail
54P-1JN4-04-02	JICM X NPTM-45-04-02 2503-04-02	7/16"	1/8"		
54P-1JN4-04-04	JICM X NPTM-45-04-04 2503-04-04	7/16"	1/4"		
54P-1JN4-04-06	JICM X NPTM-45-04-06 2503-04-06	7/16"	3/8"		
54P-1JN4-05-02	JICM X NPTM-45-05-02 2503-05-02	1/2"	1/8"		
54P-1JN4-05-04	JICM X NPTM-45-05-04 2503-05-04	1/2"	1/4"		
54P-1JN4-06-02	JICM X NPTM-45-06-02 2503-06-02	9/16"	1/8"		
54P-1JN4-06-04	JICM X NPTM-45-06-04 2503-06-04	9/16"	1/4"		
54P-1JN4-06-06	JICM X NPTM-45-06-06 2503-06-06	9/16"	3/8"		
54P-1JN4-06-08	JICM X NPTM-45-06-08 2503-06-08	9/16"	1/2"		
54P-1JN4-08-04	JICM X NPTM-45-08-04 2503-08-04	3/4"	1/4"		
54P-1JN4-08-06	JICM X NPTM-45-08-06 2503-08-06	3/4"	3/8"		
54P-1JN4-08-08	JICM X NPTM-45-08-08 2503-08-08	3/4"	1/2"		
54P-1JN4-08-12	JICM X NPTM-45-08-12 2503-08-12	3/4"	3/4"		
54P-1JN4-10-06	JICM X NPTM-45-10-06 2503-10-06	7/8"	3/8"		
54P-1JN4-10-08	JICM X NPTM-45-10-08 2503-10-08	7/8"	1/2"		
54P-1JN4-10-12	JICM X NPTM-45-10-12 2503-10-12	7/8"	3/4"		
54P-1JN4-12-08	JICM X NPTM-45-12-08 2503-12-08	1 1/16"	1/2"		
54P-1JN4-12-12	JICM X NPTM-45-12-12 2503-12-12	1 1/16"	3/4"		
54P-1JN4-12-16	JICM X NPTM-45-12-16 2503-12-16	1 1/16"	1"		
54P-1JN4-16-12	JICM X NPTM-45-16-12 2503-16-12	1 5/16"	3/4"		
54P-1JN4-16-16	JICM X NPTM-45-16-16 2503-16-16	1 5/16"	1"		
54P-1JN4-16-20	JICM X NPTM-45-16-20 2503-16-20	1 5/16"	1 1/4"		
54P-1JN4-20-16	JICM X NPTM-45-20-16 2503-20-16	1 5/8"	1"		
54P-1JN4-20-20	JICM X NPTM-45-20-20 2503-20-20	1 5/8"	1 1/4"		
54P-1JN4-24-24	JICM X NPTM-45-24-24 2503-24-24	1 7/8"	1 1/2"		
54P-1JN4-32-32	JICM X NPTM-45-32-32 2503-32-32	2 1/2"	2"		

JIC MALE X NPT MALE 90° FIXED ELBOW

Part No	Description	Jic	Npt	Visual	Retail
54P-1JN9-04-02	JICM X NPTM-90-04-02 2501-04-02	7/16"	1/8"		
54P-1JN9-04-04	JICM X NPTM-90-04-04 2501-04-04	7/16"	1/4"		
54P-1JN9-04-06	JICM X NPTM-90-04-06 2501-04-06	7/16"	3/8"		
54P-1JN9-04-08	JICM X NPTM-90-04-08 2501-04-08	7/16"	1/2"		
54P-1JN9-05-02	JICM X NPTM-90-05-02 2501-05-02	1/2"	1/8"		
54P-1JN9-05-04	JICM X NPTM-90-05-04 2501-05-04	1/2"	1/4"		
54P-1JN9-06-02	JICM X NPTM-90-06-02 2501-06-02	9/16"	1/8"		
54P-1JN9-06-04	JICM X NPTM-90-06-04 2501-06-04	9/16"	1/4"		
54P-1JN9-06-06	JICM X NPTM-90-06-06 2501-06-06	9/16"	3/8"		
54P-1JN9-06-08	JICM X NPTM-90-06-08 2501-06-08	9/16"	1/2"		
54P-1JN9-08-04	JICM X NPTM-90-08-04 2501-08-04	3/4"	1/4"		
54P-1JN9-08-06	JICM X NPTM-90-08-06 2501-08-06	3/4"	3/8"		
54P-1JN9-08-08	JICM X NPTM-90-08-08 2501-08-08	3/4"	1/2"		
54P-1JN9-08-12	JICM X NPTM-90-08-12 2501-08-12	3/4"	3/4"		
54P-1JN9-10-06	JICM X NPTM-90-10-06 2501-10-06	7/8"	3/8"		
54P-1JN9-10-08	JICM X NPTM-90-10-08 2501-10-08	7/8"	1/2"		
54P-1JN9-10-12	JICM X NPTM-90-10-12 2501-10-12	7/8"	3/4"		
54P-1JN9-12-08	JICM X NPTM-90-12-08 2501-12-08	1 1/16"	1/2"		
54P-1JN9-12-12	JICM X NPTM-90-12-12 2501-12-12	1 1/16"	3/4"		
54P-1JN9-12-16	JICM X NPTM-90-12-16 2501-12-16	1 1/16"	1"		
54P-1JN9-16-12	JICM X NPTM-90-16-12 2501-16-12	1 5/16"	3/4"		
54P-1JN9-16-16	JICM X NPTM-90-16-16 2501-16-16	1 5/16"	1"		
54P-1JN9-16-20	JICM X NPTM-90-16-20 2501-16-20	1 5/16"	1 1/4"		
54P-1JN9-20-16	JICM X NPTM-90-20-16 2501-20-16	1 5/8"	1"		
54P-1JN9-20-20	JICM X NPTM-90-20-20 2501-20-20	1 5/8"	1 1/4"		
54P-1JN9-24-20	JICM X NPTM-90-24-20 2501-24-20	1 7/8"	1 1/4"		
54P-1JN9-24-24	JICM X NPTM-90-24-24 2501-24-24	1 7/8"	1 1/2"		
54P-1JN9-32-32	JICM X NPTM-90-32-32 2501-32-32	2 1/2"	2"		

J.I.C. ADAPTORS

Retail

Prices

JIC MALE X SAE O RING MALE

30-03-2023

Part No	Description	Jic	Sae	Visual	Retail
54P-1JO-04-04	JICM X SAE0-04-04 6400-04-04	7/16"	7/16"		
54P-1JO-04-05	JICM X SAE0-04-05 6400-04-05	7/16"	1/2"		
54P-1JO-04-06	JICM X SAE0-04-06 6400-04-06	7/16"	9/16"		
54P-1JO-04-08	JICM X SAE0-04-08 6400-04-08	7/16"	3/4"		
54P-1JO-05-05	JICM X SAE0-05-05 6400-05-05	1/2"	1/2"		
54P-1JO-05-06	JICM X SAE0-05-06 6400-05-06	1/2"	9/16"		
54P-1JO-06-04	JICM X SAE0-06-04 6400-06-04	9/16"	7/16"		
54P-1JO-06-05	JICM X SAE0-06-05 6400-06-05	9/16"	1/2"		
54P-1JO-06-06	JICM X SAE0-06-06 6400-06-06	9/16"	9/16"		
54P-1JO-06-08	JICM X SAE0-06-08 6400-06-08	9/16"	3/4"		
54P-1JO-06-10	JICM X SAE0-06-10 6400-06-10	9/16"	7/8"		
54P-1JO-08-04	JICM X SAE0-08-04 6400-08-04	3/4"	7/16"		
54P-1JO-08-06	JICM X SAE0-08-06 6400-08-06	3/4"	9/16"		
54P-1JO-08-08	JICM X SAE0-08-08 6400-08-08	3/4"	3/4"		
54P-1JO-08-10	JICM X SAE0-08-10 6400-08-10	3/4"	7/8"		
54P-1JO-08-12	JICM X SAE0-08-12 6400-08-12	3/4"	1 1/16"		
54P-1JO-08-16	JICM X SAE0-08-16 6400-08-16	3/4"	1 5/16"		
54P-1JO-10-08	JICM X SAE0-10-08 6400-10-08	7/8"	3/4"		
54P-1JO-10-10	JICM X SAE0-10-10 6400-10-10	7/8"	7/8"		
54P-1JO-10-12	JICM X SAE0-10-12 6400-10-12	7/8"	1 1/16"		
54P-1JO-12-06	JICM X SAE0-12-06 6400-12-06	1 1/16"	9/16"		
54P-1JO-12-08	JICM X SAE0-12-08 6400-12-08	1 1/16"	3/4"		
54P-1JO-12-10	JICM X SAE0-12-10 6400-12-10	1 1/16"	7/8"		
54P-1JO-12-12	JICM X SAE0-12-12 6400-12-12	1 1/16"	1 1/16"		
54P-1JO-12-16	JICM X SAE0-12-16 6400-12-16	1 1/16"	1 5/16"		
54P-1JO-16-12	JICM X SAE0-16-12 6400-16-12	1 5/16"	1 1/16"		
54P-1JO-16-16	JICM X SAE0-16-16 6400-16-16	1 5/16"	1 5/16"		
54P-1JO-16-20	JICM X SAE0-16-20 6400-16-20	1 5/16"	1 5/8"		
54P-1JO-20-16	JICM X SAE0-20-16 6400-20-16	1 5/8"	1 5/16"		
54P-1JO-20-20	JICM X SAE0-20-20 6400-20-20	1 5/8"	1 5/8"		
54P-1JO-20-24	JICM X SAE0-20-24 6400-20-24	1 5/8"	1 7/8"		
54P-1JO-24-20	JICM X SAE0-24-20 6400-24-20	1 7/8"	1 5/8"		
54P-1JO-24-24	JICM X SAE0-24-24 6400-24-24	1 7/8"	1 7/8"		
54P-1JO-32-32	JICM X SAE0-32-32 6400-32-32	2 1/2"	2 1/2"		

J.I.C. ADAPTORS

Retail

Prices

JIC MALE X SAE O' RING MALE 45°

30-03-2023

Part No	Description	Jic	Sae	Visual	Retail
54P-1JO4-04-04	JICM X SAE0-45-04-04 6802-04-04	7/16"	7/16"		
54P-1JO4-04-06	JICM X SAE0-45-04-06 6802-04-06	7/16"	9/16"		
54P-1JO4-05-05	JICM X SAE0-45-05-05 6802-05-05	1/2"	1/2"		
54P-1JO4-06-04	JICM X SAE0-45-06-04 6802-06-04	9/16"	7/16"		
54P-1JO4-06-06	JICM X SAE0-45-06-06 6802-06-06	9/16"	9/16"		
54P-1JO4-06-08	JICM X SAE0-45-06-08 6802-06-08	9/16"	3/4"		
54P-1JO4-08-06	JICM X SAE0-45-08-06 6802-08-06	3/4"	9/16"		
54P-1JO4-08-08	JICM X SAE0-45-08-08 6802-08-08	3/4"	3/4"		
54P-1JO4-08-10	JICM X SAE0-45-08-10 6802-08-10	3/4"	7/8"		
54P-1JO4-08-12	JICM X SAE0-45-08-12 6802-08-12	3/4"	1 1/16"		
54P-1JO4-10-08	JICM X SAE0-45-10-08 6802-10-08	7/8"	3/4"		
54P-1JO4-10-10	JICM X SAE0-45-10-10 6802-10-10	7/8"	7/8"		
54P-1JO4-10-12	JICM X SAE0-45-10-12 6802-10-12	7/8"	1 1/16"		
54P-1JO4-12-08	JICM X SAE0-45-12-08 6802-12-08	1 1/16"	3/4"		
54P-1JO4-12-10	JICM X SAE0-45-12-10 6802-12-10	1 1/16"	7/8"		
54P-1JO4-12-12	JICM X SAE0-45-12-12 6802-12-12	1 1/16"	1 1/16"		
54P-1JO4-12-16	JICM X SAE0-45-12-16 6802-12-16	1 1/16"	1 5/16"		
54P-1JO4-16-16	JICM X SAE0-45-16-16 6802-16-16	1 5/16"	1 5/16"		
54P-1JO4-20-20	JICM X SAE0-45-20-20 6802-20-20	1 5/8"	1 5/8"		
54P-1JO4-24-24	JICM X SAE0-45-24-24 6802-24-24	1 7/8"	1 7/8"		

JIC MALE X SAE O' RING MALE 90° ADJUSTABLE ELBOW

Part No	Description	Jic	Sae	Visual	Retail
54P-1JO9-04-04	JICM X SAE0-90-04-04 6801-04-04	7/16"	7/16"		
54P-1JO9-04-05	JICM X SAE0-90-04-05 6801-04-05	7/16"	1/2"		
54P-1JO9-04-06	JICM X SAE0-90-04-06 6801-04-06	7/16"	9/16"		
54P-1JO9-04-08	JICM X SAE0-90-04-08 6801-04-08	7/16"	3/4"		
54P-1JO9-05-04	JICM X SAE0-90-05-04 6801-05-04	1/2"	7/16"		
54P-1JO9-05-05	JICM X SAE0-90-05-05 6801-05-05	1/2"	1/2"		
54P-1JO9-05-06	JICM X SAE0-90-05-06 6801-05-06	1/2"	9/16"		
54P-1JO9-06-04	JICM X SAE0-90-06-04 6801-06-04	9/16"	7/16"		
54P-1JO9-06-05	JICM X SAE0-90-06-05 6801-06-05	9/16"	1/2"		
54P-1JO9-06-06	JICM X SAE0-90-06-06 6801-06-06	9/16"	9/16"		
54P-1JO9-06-08	JICM X SAE0-90-06-08 6801-06-08	9/16"	3/4"		
54P-1JO9-06-10	JICM X SAE0-90-06-10 6801-06-10	9/16"	7/8"		
54P-1JO9-08-06	JICM X SAE0-90-08-06 6801-08-06	3/4"	9/16"		
54P-1JO9-08-08	JICM X SAE0-90-08-08 6801-08-08	3/4"	3/4"		
54P-1JO9-08-10	JICM X SAE0-90-08-10 6801-08-10	3/4"	7/8"		
54P-1JO9-08-12	JICM X SAE0-90-08-12 6801-08-12	3/4"	1 1/16"		
54P-1JO9-10-08	JICM X SAE0-90-10-08 6801-10-08	7/8"	3/4"		
54P-1JO9-10-10	JICM X SAE0-90-10-10 6801-10-10	7/8"	7/8"		
54P-1JO9-10-12	JICM X SAE0-90-10-12 6801-10-12	7/8"	1 1/16"		
54P-1JO9-12-08	JICM X SAE0-90-12-08 6801-12-08	1 1/16"	3/4"		
54P-1JO9-12-10	JICM X SAE0-90-12-10 6801-12-10	1 1/16"	7/8"		
54P-1JO9-12-12	JICM X SAE0-90-12-12 6801-12-12	1 1/16"	1 1/16"		
54P-1JO9-12-16	JICM X SAE0-90-12-16 6801-12-16	1 1/16"	1 5/16"		
54P-1JO9-16-12	JICM X SAE0-90-16-12 6801-16-12	1 5/16"	1 1/16"		
54P-1JO9-16-16	JICM X SAE0-90-16-16 6801-16-16	1 5/16"	1 5/16"		
54P-1JO9-16-20	JICM X SAE0-90-16-20 6801-16-20	1 5/16"	1 5/8"		
54P-1JO9-20-16	JICM X SAE0-90-20-16 6801-20-16	1 5/8"	1 5/16"		
54P-1JO9-20-20	JICM X SAE0-90-20-20 6801-20-20	1 5/8"	1 5/8"		
54P-1JO9-24-24	JICM X SAE0-90-24-24 6801-24-24	1 7/8"	1 7/8"		
54P-1JO9-32-32	JICM X SAE0-90-32-32 6801-32-32	2 1/2"	2 1/2"		

J.I.C ADAPTORS

Retail

Prices

JIC MALE X JIC FEMALE SWIVEL

19-07-2023

Part No	Description	Jic	Jic	Visual	Retail
54P-2J-04	JICM X JICF-04-04 6504-04-04	7/16"	7/16"		
54P-2J-04-06	JICM X JICF-04-06 6504-04-06	7/16"	9/16"		
54P-2J-04-08	JICM X JICF-04-08 6504-04-08	7/16"	3/4"		
54P-2J-04-10	JICM X JICF-04-10 6504-04-10	7/16"	7/8"		
54P-2J-06	JICM X JICF-06-06 6504-06-06	9/16"	9/16"		
54P-2J-06-08	JICM X JICF-06-08 6504-06-08	9/16"	3/4"		
54P-2J-08	JICM X JICF-08-08 6504-08-08	3/4"	3/4"		
54P-2J-08-10	JICM X JICF-08-10 6504-08-10	3/4"	7/8"		
54P-2J-08-12	JICM X JICF-08-12 6504-08-12	3/4"	1 1/16"		
54P-2J-08-16	JICM X JICF-08-16 6504-08-16	3/4"	1 5/16"		
54P-2J-10	JICM X JICF-10-10 6504-10-10	7/8"	7/8"		
54P-2J-10-12	JICM X JICF-10-12 6504-10-12	7/8"	1 1/16"		
54P-2J-12	JICM X JICF-12-12 6504-12-12	1 1/16"	1 1/16"		
54P-2J-12-16	JICM X JICF-12-16 6504-12-16	1 1/16"	1 5/16"		
54P-2J-16	JICM X JICF-16-16 6504-16-16	1 5/16"	1 5/16"		
54P-2J-20	JICM X JICF-20-20 6500-20-20	1 5/8"	1 5/8"		

JIC MALE X JIC FEMALE SWIVEL 45°

Part No	Description	Jic	Jic	Visual	Retail
54P-2J4-04	JICM X JICF-45-04-04 6502-04-04	7/16"	7/16"		
54P-2J4-05	JICM X JICF-45-05-05 6502-05-05	1/2"	1/2"		
54P-2J4-06	JICM X JICF-45-06-06 6502-06-06	9/16"	9/16"		
54P-2J4-08	JICM X JICF-45-08-08 6502-08-08	3/4"	3/4"		
54P-2J4-10	JICM X JICF-45-10-10 6502-10-10	7/8"	7/8"		
54P-2J4-12	JICM X JICF-45-12-12 6502-12-12	1 1/16"	1 1/16"		
54P-2J4-16	JICM X JICF-45-16-16 6502-16-16	1 5/16"	1 5/16"		
54P-2J4-20	JICM X JICF-45-20-20 6502-20-20	1 5/8"	1 5/8"		
54P-2J4-24	JICM X JICF-45-24-24 6502-24-24	1 7/8"	1 7/8"		
54P-2J4-32	JICM X JICF-45-32-32 6502-32-32	2 1/2"	2 1/2"		

JIC MALE X JIC FEMALE SWIVEL 90°

Part No	Description	Jic	Jic	Visual	Retail
54P-2J9-04	JICM X JICF-90-04-04 6500-04-04	7/16"	7/16"		
54P-2J9-05	JICM X JICF-90-05-05 6500-05-05	1/2"	1/2"		
54P-2J9-06	JICM X JICF-90-06-06 6500-06-06	9/16"	9/16"		
54P-2J9-08	JICM X JICF-90-08-08 6500-08-08	3/4"	3/4"		
54P-2J9-10	JICM X JICF-90-10-10 6500-10-10	7/8"	7/8"		
54P-2J9-12	JICM X JICF-90-12-12 6500-12-12	1 1/16"	1 1/16"		
54P-2J9-16	JICM X JICF-90-16-16 6500-16-16	1 5/16"	1 5/16"		
54P-2J9-20	JICM X JICF-90-20-20 6500-20-20	1 5/8"	1 5/8"		
54P-2J9-24	JICM X JICF-90-24-24 6500-24-24	1 7/8"	1 7/8"		
54P-2J9-32	JICM X JICF-90-32-32 6500-32-32	2 1/2"	2 1/2"		

JIC MALE X BSPP FEMALE SWIVEL

Part No	Description	Jic	Bspp	Visual	Retail
54P-2JB-06	JICM X BSPF-06-06	9/16"	3/8"		
54P-2JB-08	JICM X BSPF-08-08	3/4"-16	1/2"		
54P-2JB-12	JICM X BSPF-12-12	1 1/16"	3/4"		
54P-2JB-16	JICM X BSPF-16-16	1 5/16"	1"		

JIC FEMALE X JIC FEMALE SWIVEL

Part No	Description	Jic	Jic	Visual	Retail
54P-3J-06	JICF X JICF-06-06	9/16"	9/16"		
54P-3J-08	JICF X JICF-08-08	3/4"-16	3/4"-16		
54P-3J-10	JICF X JICF-10-10	7/8"-14	7/8"-14		
54P-3J-12	JICF X JICF-12-12	1 1/16"	1 1/16"		
54P-3J-16	JICF X JICF-16-16	1 5/16"	1 5/16"		

J.I.C ADAPTORS

Retail
Prices

JIC MALE PLUG

19-09-2023

Part No	Description	Jic	Jic	Visual	Retail
54P-4J-04	JICM X HEX PLUG-04 2408-04	7/16"			
54P-4J-05	JICM X HEX PLUG-05 2408-05	1/2"			
54P-4J-06	JICM X HEX PLUG-06 2408-06	9/16"			
54P-4J-08	JICM X HEX PLUG-08 2408-08	3/4"			
54P-4J-10	JICM X HEX PLUG-10 2408-10	7/8"			
54P-4J-12	JICM X HEX PLUG-12 2408-12	1 1/16"			
54P-4J-14	JICM X HEX PLUG-14 2408-14	1 3/16"			
54P-4J-16	JICM X HEX PLUG-16 2408-16	1 5/16"			
54P-4J-20	JICM X HEX PLUG-20 2408-20	1 5/8"			
54P-4J-24	JICM X HEX PLUG-24 2408-24	1 7/8"			
54P-4J-32	JICM X HEX PLUG-32 2408-32	2 1/2"			

JIC MALE X JIC FEMALE FIXED REDUCER

Part No	Description	Jic	Jic	Visual	Retail
54P-5J-06-04	JICM X JICF-06-04 2406-06-04	9/16"	7/16"		
54P-5J-08-04	JICM X JICF-08-04 2406-08-04	3/4"	7/16"		
54P-5J-08-06	JICM X JICF-08-06 2406-08-06	3/4"	9/16"		
54P-5J-10-06	JICM X JICF-10-06 2406-10-06	7/8"	9/16"		
54P-5J-10-08	JICM X JICF-10-08 2406-10-08	7/8"	3/4"		
54P-5J-10-12	JICM X JICF-10-12 2406-10-12	7/8"	1 1/16"		
54P-5J-12-06	JICM X JICF-12-06 2406-12-06	1 1/16"	9/16"		
54P-5J-12-08	JICM X JICF-12-08 2406-12-08	1 1/16"	3/4"		
54P-5J-16-08	JICM X JICF-16-08 2406-16-08	1 5/16"	3/4"		
54P-5J-16-12	JICM X JICF-16-12 2406-16-12	1 5/16"	1 1/16"		
54P-5J-16-20	JICM X JICF-16-20 2406-16-20	1 5/16"	1 5/8"		
54P-5J-20-16	JICM X JICF-20-16 2406-20-16	1 5/8"	1 5/16"		
54P-5J-20-24	JICM X JICF-20-24 2406-20-24	1 5/8"	1 7/8"		
54P-5J-24-20	JICM X JICF-24-20 2406-24-20	1 7/8"	1 5/8"		

JIC MALE X NPT FEMALE FIXED REDUCER

Part No	Description	Jic	Npt	Visual	Retail
54P-5JN-04	JICM X NPTF-04-04 2405-04-04	7/16"	1/4"		
54P-5JN-06-04	JICM X NPTF-06-04 2405-06-04	9/16"	1/4"		
54P-5JN-06	JICM X NPTF-06-06 2405-06-06	9/16"	3/8"		
54P-5JN-08-06	JICM X NPTF-08-06 2405-08-06	3/4"	3/8"		
54P-5JN-08	JICM X NPTF-08-08 2405-08-08	3/4"	1/2"		
54P-5JN-12	JICM X NPTF-12-12 2405-12-12	1 1/16"	3/4"		
54P-5JN-16	JICM X NPTF-16-16 2405-16-16	1 5/16"	1"		

JIC MALE X NPT FEMALE FIXED X 90°

Part No	Description	Jic	Npt	Visual	Retail
54P-5JN9-04	JICM X NPTF-90-04-04 2502-04-04	7/16"	1/4"		
54P-5JN9-06	JICM X NPTF-90-06-06 2502-06-06	9/16"	3/8"		
54P-5JN9-08	JICM X NPTF-90-08-08 2502-08-08	3/4"	1/2"		
54P-5JN9-12	JICM X NPTF-90-12-12 2502-12-12	1 1/16"	3/4"		
54P-5JN9-16	JICM X NPTF-90-16-16 2502-16-16	1 5/16"	1"		

J.I.C ADAPTORS

Retail

Prices

JIC BULKHEAD & LOCKNUT

19-07-2023

Part No	Description	Jic	Jic	Visual	Retail
54P-6J-LN-04	JIC X BULKHEAD-04-04 2700-04-04	7/16"	7/16"		
54P-6J-LN-05	JIC X BULKHEAD-05-05 2700-05-05	1/2"	1/2"		
54P-6J-LN-06	JIC X BULKHEAD-06-06 2700-06-06	9/16"	9/16"		
54P-6J-LN-08	JIC X BULKHEAD-08-08 2700-08-08	3/4"	3/4"		
54P-6J-LN-10	JIC X BULKHEAD-10-10 2700-10-10	7/8"	7/8"		
54P-6J-LN-12	JIC X BULKHEAD-12-12 2700-12-12	1 1/16"	1 1/16"		
54P-6J-LN-16	JIC X BULKHEAD-16-16 2700-16-16	1 5/16"	1 5/16"		
54P-6J-LN-20	JIC X BULKHEAD-20-20 2700-20-20	1 5/8"	1 5/8"		
54P-6J-LN-24	JIC X BULKHEAD-24-24 2700-24-24	1 7/8"	1 7/8"		

JIC BULKHEAD & LOCKNUT 45°

Part No	Description	Jic	Jic	Visual	Retail
54P-6J4-LN-04	JIC X BULKHEAD-45-04-04	7/16"	7/16"		
54P-6J4-LN-06	JIC X BULKHEAD-45-06-06	9/16"	9/16"		
54P-6J4-LN-08	JIC X BULKHEAD-45-08-08	3/4"	3/4"		
54P-6J4-LN-10	JIC X BULKHEAD-45-10-10	7/8"	7/8"		
54P-6J4-LN-12	JIC X BULKHEAD-45-12-12	1 1/16"	1 1/16"		

JIC BULKHEAD & LOCKNUT 90°

Part No	Description	Jic	Jic	Visual	Retail
54P-6J9-LN-04	JIC X BULKHEAD-90-04-04 2701-04-04	7/16"	7/16"		
54P-6J9-LN-05	JIC X BULKHEAD-90-05-05 2701-05-05	1/2"	1/2"		
54P-6J9-LN-06	JIC X BULKHEAD-90-06-06 2701-06-06	9/16"	9/16"		
54P-6J9-LN-08	JIC X BULKHEAD-90-08-08 2701-08-08	3/4"	3/4"		
54P-6J9-LN-10	JIC X BULKHEAD-90-10-10 2701-10-10	7/8"	7/8"		
54P-6J9-LN-12	JIC X BULKHEAD-90-12-12 2701-12-12	1 1/16"	1 1/16"		
54P-6J9-LN-16	JIC X BULKHEAD-90-16-16 2701-16-16	1 5/16"	1 5/16"		
54P-6J9-LN-20	JIC X BULKHEAD-90-20-20 2701-20-20	1 5/8"	1 5/8"		

JIC BULKHEAD LOCKNUT

Part No	Description	Jic	Jic	Visual	Retail
54P-8J-04	JIC X LOCK NUT-04 0306-04	7/16"	7/16"		
54P-8J-05	JIC X LOCK NUT-05 0306-05	1/2"	1/2"		
54P-8J-06	JIC X LOCK NUT-06 0306-06	9/16"	9/16"		
54P-8J-08	JIC X LOCK NUT-08 0306-08	3/4"	3/4"		
54P-8J-10	JIC X LOCK NUT-10 0306-10	7/8"	7/8"		
54P-8J-12	JIC X LOCK NUT-12 0306-12	1 1/16"	1 1/16"		
54P-8J-16	JIC X LOCK NUT-16 0306-16	1 5/16"	1 5/16"		
54P-8J-20	JIC X LOCK NUT-20 0306-20	1 5/8"	1 5/8"		
54P-8J-24	JIC X LOCK NUT-24 0306-24	1 7/8"	1 7/8"		

JIC FEMALE CAP

Part No	Description	Size		Visual	Retail
54P-9J-04	JICF X HEX CAP-04 304C-04	7/16"			
54P-9J-05	JICF X HEX CAP-05 304C-05	1/2"			
54P-9J-06	JICF X HEX CAP-06 304C-06	9/16"			
54P-9J-08	JICF X HEX CAP-08 304C-08	3/4"			
54P-9J-10	JICF X HEX CAP-10 304C-10	7/8"			
54P-9J-12	JICF X HEX CAP-12 304C-12	1 1/16"			
54P-9J-16	JICF X HEX CAP-16 304C-16	1 5/16"			
54P-9J-20	JICF X HEX CAP-20 304C-20	1 5/8"			
54P-9J-24	JICF X HEX CAP-24 304C-24	1 7/8"			
54P-9J-32	JICF X HEX CAP-32 304C-32	2 1/2"			

J.I.C ADAPTORS

Retail

Prices

01-10-2022

JIC MALE TEE

Part No	Description	Jic	Jic	Visual	Retail
54P-AJ-04	JIC M/M/M T-04-04-04 2603-04-04-04	7/16"	7/16"		
54P-AJ-05	JIC M/M/M T-05-05-05 2603-05-05-05	5/16"	5/16"		
54P-AJ-06	JIC M/M/M T-06-06-06 2603-06-06-06	9/16"	9/16"		
54P-AJ-08	JIC M/M/M T-08-08-08 2603-08-08-08	3/4"	3/4"		
54P-AJ-10	JIC M/M/M T-10-10-10 2603-10-10-10	7/8"	7/8"		
54P-AJ-12	JIC M/M/M T-12-12-12 2603-12-12-12	1 1/16"	1 1/16"		
54P-AJ-16	JIC M/M/M T-16-16-16 2603-16-16-16	1 5/16"	1 5/16"		
54P-AJ-20	JIC M/M/M T-20-20-20 2603-20-20-20	1 5/8"	1 5/8"		

JIC MALE X NPT MALE RUN TEE

Part No	Description	Jic	Npt	Visual	Retail
54P-AJJN-04	JIC M/M X NPTM RUN T-04-04-04 2605	7/16"	1/4"		
54P-AJJN-060604	JIC M/M X NPTM RUN T-06-06-04 2605	9/16"	1/4"		
54P-AJJN-06	JIC M/M X NPTM RUN T-06-06-06 2605	9/16"	3/8"		
54P-AJJN-080806	JIC M/M X NPTM RUN T-08-08-06 2605	3/4"	3/8"		
54P-AJJN-08	JIC M/M X NPTM RUN T-08-08-08 2605	3/4"	1/2"		
54P-AJJN-101008	JIC M/M X NPTM RUN T-10-10-08 2605	7/8"	1/2"		
54P-AJJN-101012	JIC M/M X NPTM RUN T-10-10-12 2605	7/8"	3/4"		
54P-AJJN-12	JIC M/M X NPTM RUN T-12-12-12 2605	1 1/16"	3/4"		
54P-AJJN-16	JIC M/M X NPTM RUN T-16-16-16 2605	1 5/16"	1"		

JIC MALE X SAE MALE RUN TEE

Part No	Description	Jic	Sae	Visual	Retail
54P-AJJO-04	JIC M/M X SAEM RUN-T-04-04-04	7/16"	7/16"		
54P-AJJO-05	JIC M/M X SAEM RUN-T-05-05-05	1/2-20"	1/2-20"		
54P-AJJO-06	JIC M/M X SAEM RUN-T-06-06-06	9/16"	9/16"		
54P-AJJO-08	JIC M/M X SAEM RUN-T-08-08-08	3/4-16"	3/4-16"		
54P-AJJO-10	JIC M/M X SAEM RUN-T-10-10-10	7/8"	7/8"		
54P-AJJO-12	JIC M/M X SAEM RUN-T-12-12-12	1 1/16"	1 1/16"		
54P-AJJO-16	JIC M/M X SAEM RUN-T-16-16-16	1 5/16"	1 5/16"		
54P-AJJO-20	JIC M/M X SAEM RUN-T-20-20-20	1 5/8"	1 5/8"		

JIC MALE X NPT MALE BRANCH TEE

Part No	Description	Jic	Npt	Visual	Retail
54P-AJNJ-04	JIC M/M X NPTM BRANCH T-04-04-04 2601	7/16"	1/4"		
54P-AJNJ-060604	JIC M/M X NPTM BRANCH T-06-06-04 2601	9/16"	1/4"		
54P-AJNJ-06	JIC M/M X NPTM BRANCH T-06-06-06 2601	9/16"	3/8"		
54P-AJNJ-080806	JIC M/M X NPTM BRANCH T-08-08-06 2601	3/4"	3/8"		
54P-AJNJ-08	JIC M/M X NPTM BRANCH T-08-08-08 2601	3/4"	1/2"		
54P-AJNJ-100810	JIC M/M X NPTM BRANCH T-10-08-10 2601	7/8"	1/2"		
54P-AJNJ-12	JIC M/M X NPTM BRANCH T-12-12-12 2601	1 1/16"	3/4"		
54P-AJNJ-16	JIC M/M X NPTM BRANCH T-16-16-16 2601	1 5/16"	1"		

JIC MALE X SAE MALE BRANCH TEE

Part No	Description	Jic	Sae	Visual	Retail
54P-AJOJ-04	JIC M/M X SAEM-BRANCH-T-04-04-04	7/16"	7/16"		
54P-AJOJ-05	JIC M/M X SAEM-BRANCH-T-05-05-05	1/2-20"	1/2-20"		
54P-AJOJ-06	JIC M/M X SAEM-BRANCH-T-06-06-06	9/16"	9/16"		
54P-AJOJ-08	JIC M/M X SAEM-BRANCH-T-08-08-08	3/4-16"	3/4-16"		
54P-AJOJ-10	JIC M/M X SAEM-BRANCH-T-10-10-10	7/8"	7/8"		
54P-AJOJ-12	JIC M/M X SAEM-BRANCH-T-12-12-12	1 1/16"	1 1/16"		
54P-AJOJ-16	JIC M/M X SAEM-BRANCH-T-16-16-16	1 5/16"	1 5/16"		
54P-AJOJ-20	JIC M/M X SAEM-BRANCH-T-20-20-20	1 5/8"	1 5/8"		

J.I.C ADAPTORS

Retail

Prices

JIC MALE X JIC FEMALE BRANCH TEE

30-03-2023

Part No	Description	Jic	Jic	Visual	Retail
54P-BJ-04	JIC M/M/F-04-04-04 6600-04-04-04	7/16"	7/16"		
54P-BJ-05	JIC M/M/F-05-05-05 6600-05-05-05	1/2"	1/2"		
54P-BJ-06	JIC M/M/F-06-06-06 6600-06-06-06	9/16"	9/16"		
54P-BJ-08	JIC M/M/F-08-08-08 6600-08-08-08	3/4"	3/4"		
54P-BJ-10	JIC M/M/F-10-10-10 6600-10-10-10	7/8"	7/8"		
54P-BJ-12	JIC M/M/F-12-12-12 6600-12-12-12	1 1/16"	1 1/16"		
54P-BJ-16	JIC M/M/F-16-16-16 6600-16-16-16	1 5/16"	1 5/16"		
54P-BJ-20	JIC M/M/F-20-20-20 6600-20-20-20	1 5/8"	1 5/8"		

JIC MALE X JIC FEMALE RUN TEE

Part No	Description	Jic	Jic	Visual	Retail
54P-CJ-04	JIC M/M/F RUN T-04-04-04 6602-04-04-04	7/16"	7/16"		
54P-CJ-05	JIC M/M/F RUN T-05-05-05 6602-05-05-05	1/2"	1/2"		
54P-CJ-06	JIC M/M/F RUN T-06-06-06 6602-06-06-06	9/16"	9/16"		
54P-CJ-08	JIC M/M/F RUN T-08-08-08 6602-08-08-08	3/4"	3/4"		
54P-CJ-10	JIC M/M/F RUN T-10-10-10 6602-10-10-10	7/8"	7/8"		
54P-CJ-12	JIC M/M/F RUN T-12-12-12 6602-12-12-12	1 1/16"	1 1/16"		
54P-CJ-16	JIC M/M/F RUN T-16-16-16 6602-16-16-16	1 5/16"	1 5/16"		
54P-CJ-20	JIC M/M/F RUN T-20-20-20 6602-20-20-20	1 5/8"	1 5/8"		
54P-CJ-24	JIC M/M/F RUN T-24-24-24 6602-24-24-24	1 7/8"	1 7/8"		

O.R.F.S. ADAPTORS

Retail

Prices

ORFS MALE NIPPLE

19-09-2023

Part No	Description	Orfs	Orfs	Visual	Retail
54P-1F-04-04	ORFSM X ORFSM-04-04 FF2403-04-04	9/16" -18	9/16" -18		
54P-1F-04-06	ORFSM X ORFSM-06-04 FF2403-06-04	11/16" -16	9/16" -18		
54P-1F-06-06	ORFSM X ORFSM-06-06 FF2403-06-06	11/16" -16	11/16" -16		
54P-1F-06-08	ORFSM X ORFSM-08-06 FF2403-08-06	13/16" -16	11/16" -16		
54P-1F-08-08	ORFSM X ORFSM-08-08 FF2403-08-08	13/16" -16	13/16" -16		
54P-1F-08-10	ORFSM X ORFSM-10-08 FF2403-10-08	1" -14	13/16" -16		
54P-1F-10-10	ORFSM X ORFSM-10-10 FF2403-10-10	1" -14	1" -14		
54P-1F-10-12	ORFSM X ORFSM-12-10 FF2403-12-10	1 3/16" -12	1" -14		
54P-1F-12-12	ORFSM X ORFSM-12-12 FF2403-12-12	1 3/16" -12	1 3/16" -12		
54P-1F-12-16	ORFSM X ORFSM-16-12 FF2403-16-12	1 7/16" -12	1 3/16" -12		
54P-1F-16-16	ORFSM X ORFSM-16-16 FF2403-16-16	1 7/16" -12	1 7/16" -12		
54P-1F-20-20	ORFSM X ORFSM-20-20 FF2403-20-20	1 11/16" -12	1 11/16" -12		
54P-1F-24-24	ORFSM X ORFSM-24-24 FF2403-24-24	2" -12	2" -12		

ORFS MALE X ORFS MALE 90°

Part No	Description	Orfs	Orfs	Visual	Retail
54P-1F9-04-04	ORFSM X ORFSM-90-04-04	9/16"	9/16"		
54P-1F9-06-06	ORFSM X ORFSM-90-06-06	11/16"	11/16"		
54P-1F9-08-08	ORFSM X ORFSM-90-08-08	13/16"	13/16"		
54P-1F9-10-10	ORFSM X ORFSM-90-10-10	1" -14	1" -14		
54P-1F9-12-12	ORFSM X ORFSM-90-12-12	1 3/16"	1 1/16"		
54P-1F9-16-16	ORFSM X ORFSM-90-16-16	1 7/16"	1 7/16"		
54P-1F9-20-20	ORFSM X ORFSM-90-20-20	1 11/16"	1 11/16"		
54P-1F9-24-24	ORFSM X ORFSM-90-24-24	2" -12	2" -12		

ORFS MALE X BSP MALE

Part No	Description	Orfs	Bsp	Visual	Retail
54P-1FG-04-04	ORFSM X BSPM-04-04 FFC40XS-04-04	9/16" -18	1/4"		
54P-1FG-06-04	ORFSM X BSPM-06-04 FFC40XS-06-04	11/16" -16	1/4"		
54P-1FG-06-06	ORFSM X BSPM-06-06 FFC40XS-06-06	11/16" -16	3/8"		
54P-1FG-06-08	ORFSM X BSPM-06-08 FFC40XS-06-08	11/16" -16	1/2"		
54P-1FG-08-06	ORFSM X BSPM-08-06 FFC40XS-08-06	13/16" -16	3/8"		
54P-1FG-08-08	ORFSM X BSPM-08-08 FFC40XS-08-08	13/16" -16	1/2"		
54P-1FG-08-12	ORFSM X BSPM-08-12 FFC40XS-08-12	13/16" -16	3/4"		
54P-1FG-10-06	ORFSM X BSPM-10-06 FFC40XS-10-06	1" -14	3/8"		
54P-1FG-10-08	ORFSM X BSPM-10-08 FFC40XS-10-08	1" -14	1/2"		
54P-1FG-10-12	ORFSM X BSPM-10-12 FFC40XS-10-12	1" -14	3/4"		
54P-1FG-12-08	ORFSM X BSPM-12-08 FFC40XS-12-08	1 3/16" -12	1/2"		
54P-1FG-12-12	ORFSM X BSPM-12-12 FFC40XS-12-12	1 3/16" -12	3/4"		
54P-1FG-16-16	ORFSM X BSPM-16-16 FFC40XS-16-16	1 7/16" -12	1"		

ORFS MALE X BSP MALE SWIVEL 90°

Part No	Description	Orfs	Bsp	Visual	Retail
54P-1FG9-04-04	ORFSM X BSPM-90-04-04 FFC40XS-04-04	9/16" -18	1/4"		
54P-1FG9-06-04	ORFSM X BSPM-90-06-04 FFC40XS-06-04	11/16" -16	1/4"		
54P-1FG9-06-06	ORFSM X BSPM-90-06-06 FFC40XS-06-06	11/16" -16	3/8"		
54P-1FG9-06-08	ORFSM X BSPM-90-06-08 FFC40XS-06-08	11/16" -16	1/2"		
54P-1FG9-08-06	ORFSM X BSPM-90-08-06 FFC40XS-08-06	13/16" -16	3/8"		
54P-1FG9-08-08	ORFSM X BSPM-90-08-08 FFC40XS-08-08	13/16" -16	1/2"		
54P-1FG9-08-12	ORFSM X BSPM-90-08-12 FFC40XS-08-12	13/16" -16	3/4"		
54P-1FG9-10-06	ORFSM X BSPM-90-10-06 FFC40XS-10-06	1" -14	3/8"		
54P-1FG9-10-08	ORFSM X BSPM-90-10-08 FFC40XS-10-08	1" -14	1/2"		
54P-1FG9-10-12	ORFSM X BSPM-90-10-12 FFC40XS-10-12	1" -14	3/4"		
54P-1FG9-12-08	ORFSM X BSPM-90-12-08 FFC40XS-12-08	1 3/16" -12	1/2"		
54P-1FG9-12-12	ORFSM X BSPM-90-12-12 FFC40XS-12-12	1 3/16" -12	3/4"		
54P-1FG9-16-16	ORFSM X BSPM-90-16-16 FFC40XS-16-16	1 7/16" -12	1"		

O.R.F.S ADAPTORS

Retail

Prices

ORFS MALE X NPT MALE

01-10-2022

Part No	Description	Orfs	Npt	Visual	Retail
54P-1FN-04-02	ORFSM X NPTM-04-02 FF2404-04-02	9/16"-18	1/8"		
54P-1FN-04-04	ORFSM X NPTM-04-04 FF2404-04-04	9/16"-18	1/4"		
54P-1FN-04-06	ORFSM X NPTM-04-06 FF2404-04-06	9/16"-18	3/8"		
54P-1FN-04-08	ORFSM X NPTM-04-08 FF2404-04-08	9/16"-18	1/2"		
54P-1FN-06-02	ORFSM X NPTM-06-02 FF2404-06-02	11/16"-16	1/8"		
54P-1FN-06-04	ORFSM X NPTM-06-04 FF2404-06-04	11/16"-16	1/4"		
54P-1FN-06-06	ORFSM X NPTM-06-06 FF2404-06-06	11/16"-16	3/8"		
54P-1FN-06-08	ORFSM X NPTM-06-08 FF2404-06-08	11/16"-16	1/2"		
54P-1FN-08-04	ORFSM X NPTM-08-04 FF2404-08-04	13/16"-16	1/4"		
54P-1FN-08-06	ORFSM X NPTM-08-06 FF2404-08-06	13/16"-16	3/8"		
54P-1FN-08-08	ORFSM X NPTM-08-08 FF2404-08-08	13/16"-16	1/2"		
54P-1FN-08-12	ORFSM X NPTM-08-12 FF2404-08-12	13/16"-16	3/4"		
54P-1FN-10-08	ORFSM X NPTM-10-08 FF2404-10-08	1"-14	1/2"		
54P-1FN-10-12	ORFSM X NPTM-10-12 FF2404-10-12	1"-14	3/4"		
54P-1FN-12-08	ORFSM X NPTM-12-08 FF2404-12-08	1 3/16"-12	1/2"		
54P-1FN-12-12	ORFSM X NPTM-12-12 FF2404-12-12	1 3/16"-12	3/4"		
54P-1FN-12-16	ORFSM X NPTM-12-16 FF2404-12-16	1 3/16"-12	1"		
54P-1FN-16-12	ORFSM X NPTM-16-12 FF2404-16-12	1 7/16"-12	3/4"		
54P-1FN-16-16	ORFSM X NPTM-16-16 FF2404-16-16	1 7/16"-12	1"		
54P-1FN-16-20	ORFSM X NPTM-16-20 FF2404-16-20	1 7/16"-12	1 1/4"		
54P-1FN-24-24	ORFSM X NPTM-24-24 FF2404-24-24	2"-12	1 1/2"		

ORFS MALE X NPT MALE 45°

Part No	Description	Orfs	Npt	Visual	Retail
54P-1FN4-04-06	ORFSM X NPTM-45-04-06	9/16"	3/8"		
54P-1FN4-06-06	ORFSM X NPTM-45-06-06	11/16"	3/8"		
54P-1FN4-06-04	ORFSM X NPTM-45-06-04	11/16"	1/4"		
54P-1FN4-08-08	ORFSM X NPTM-45-08-08	13/16"	1/2"		
54P-1FN4-12-12	ORFSM X NPTM-45-12-12	1 3/16"	3/4"		

ORFS MALE X NPT MALE 90°

Part No	Description	Orfs	Npt	Visual	Retail	
54P-1FN9-04-02	ORFSM X NPTM-90-04-02 FF2501-04-02	9/16"-18	1/8"			
54P-1FN9-04-04	ORFSM X NPTM-90-04-04 FF2501-04-04	9/16"-18	1/4"			
54P-1FN9-04-06	ORFSM X NPTM-90-04-06 FF2501-04-06	9/16"-18	3/8"			
54P-1FN9-06-02	ORFSM X NPTM-90-06-02 FF2501-06-02	11/16"-16	1/8"			
54P-1FN9-06-04	ORFSM X NPTM-90-06-04 FF2501-06-04	11/16"-16	1/4"			
54P-1FN9-06-06	ORFSM X NPTM-90-06-06 FF2501-06-06	11/16"-16	3/8"			
54P-1FN9-06-08	ORFSM X NPTM-90-06-08 FF2501-06-08	11/16"-16	1/2"			
54P-1FN9-08-06	ORFSM X NPTM-90-08-06 FF2501-08-06	13/16"-16	3/8"			
54P-1FN9-08-08	ORFSM X NPTM-90-08-08 FF2501-08-08	13/16"-16	1/2"			
54P-1FN9-08-12	ORFSM X NPTM-90-08-12 FF2501-08-12	13/16"-16	3/4"			
54P-1FN9-12-08	ORFSM X NPTM-90-12-08 FF2501-12-08	1 3/16"-12	1/2"			
54P-1FN9-12-12	ORFSM X NPTM-90-12-12 FF2501-12-12	1 3/16"-12	3/4"			
54P-1FN9-12-16	ORFSM X NPTM-90-12-16 FF2501-12-16	1 3/16"-12	1"			
54P-1FN9-16-12	ORFSM X NPTM-90-16-12 FF2501-16-12	1 7/16"-12	3/4"			
54P-1FN9-16-16	ORFSM X NPTM-90-16-16 FF2501-16-16	1 7/16"-12	1"			

O.R.F.S ADAPTORS

Retail

Prices

ORFS MALE X SAE O'RING MALE

19-07-2023

Part No	Description	Orfs	Sae	Visual	Retail
54P-1FO-04	ORFSM X SAEM-04-04 FF6400-04-04	9/16"-18	7/16"		
54P-1FO-04-05	ORFSM X SAEM-04-05 FF6400-04-05	9/16"-18	1/2"		
54P-1FO-04-06	ORFSM X SAEM-04-06 FF6400-04-06	9/16"-18	9/16"		
54P-1FO-04-08	ORFSM X SAEM-04-08 FF6400-04-08	9/16"-18	3/4"		
54P-1FO-06-04	ORFSM X SAEM-06-04 FF6400-06-04	11/16"-16	7/16"		
54P-1FO-06	ORFSM X SAEM-06-06 FF6400-06-06	11/16"-16	9/16"		
54P-1FO-06-08	ORFSM X SAEM-06-08 FF6400-06-08	11/16"-16	3/4"		
54P-1FO-06-10	ORFSM X SAEM-06-10 FF6400-06-10	11/16"-16	7/8"		
54P-1FO-08-06	ORFSM X SAEM-08-06 FF6400-08-06	13/16"-16	9/16"		
54P-1FO-08	ORFSM X SAEM-08-08 FF6400-08-08	13/16"-16	3/4"		
54P-1FO-08-10	ORFSM X SAEM-08-10 FF6400-08-10	13/16"-16	7/8"		
54P-1FO-08-12	ORFSM X SAEM-08-12 FF6400-08-12	13/16"-16	1 1/16"		
54P-1FO-10-08	ORFSM X SAEM-10-08 FF6400-10-08	7/8"	3/4"		
54P-1FO-10	ORFSM X SAEM-10-10 FF6400-10-10	7/8"	7/8"		
54P-1FO-10-12	ORFSM X SAEM-10-12 FF6400-10-12	7/8"	1 1/16"		
54P-1FO-12-08	ORFSM X SAEM-12-08 FF6400-12-08	1 3/16"-12	3/4"		
54P-1FO-12-10	ORFSM X SAEM-12-10 FF6400-12-10	1 3/16"-12	7/8"		
54P-1FO-12	ORFSM X SAEM-12-12 FF6400-12-12	1 3/16"-12	1 1/16"		
54P-1FO-12-16	ORFSM X SAEM-12-16 FF6400-12-16	1 3/16"-12	1 5/16"		
54P-1FO-16-12	ORFSM X SAEM-16-12 FF6400-16-12	1 7/16"-12	1 1/16"		
54P-1FO-16	ORFSM X SAEM-16-16 FF6400-16-16	1 7/16"-12	1 5/16"		
54P-1FO-16-20	ORFSM X SAEM-16-20 FF6400-16-20	1 7/16"-12	1 5/8"		
54P-1FO-20	ORFSM X SAEM-20-20 FF6400-20-20	1 11/16"-12	1 5/8"		

ORFS MALE X SAE O'RING MALE 45°

Part No	Description	Orfs	Sae	Visual	Retail
54P-1FO4-04-04	ORFSM X SAEM-45-04-04 FF6802-04-04	9/16"-18	7/16"		
54P-1FO4-04-06	ORFSM X SAEM-45-04-06 FF6802-04-06	9/16"-18	9/16"		
54P-1FO4-06-04	ORFSM X SAEM-45-06-04 FF6802-06-04	11/16"-16	7/16"		
54P-1FO4-06-06	ORFSM X SAEM-45-06-06 FF6802-06-06	11/16"-16	9/16"		
54P-1FO4-06-08	ORFSM X SAEM-45-06-08 FF6802-06-08	11/16"-16	3/4"		
54P-1FO4-08-06	ORFSM X SAEM-45-08-06 FF6802-08-06	13/16"-16	9/16"		
54P-1FO4-08-08	ORFSM X SAEM-45-08-08 FF6802-08-08	13/16"-16	3/4"		
54P-1FO4-10-08	ORFSM X SAEM-45-10-08 FF6802-10-08	1" -14	3/4"		
54P-1FO4-10-10	ORFSM X SAEM-45-10-10 FF6802-10-10	1" -14	7/8"		
54P-1FO4-12-10	ORFSM X SAEM-45-12-10 FF6802-12-10	1 3/16"-12	7/8"		
54P-1FO4-12-12	ORFSM X SAEM-45-12-12 FF6802-12-12	1 3/16"-12	1 1/16"		
54P-1FO4-16-16	ORFSM X SAEM-45-16-16 FF6802-16-16	1 7/16"-12	1 5/16"		

ORFS MALE X SAE O'RING MALE ADJUSTABLE 90°

Part No	Description	Orfs	Sae	Visual	Retail
54P-1FO9-04-04	ORFSM X SAEM-90-04-04 FF6801-04-04	9/16"-18	7/16"		
54P-1FO9-04-06	ORFSM X SAEM-90-04-06 FF6801-04-06	9/16"-18	9/16"		
54P-1FO9-06-04	ORFSM X SAEM-90-06-04 FF6801-06-04	11/16"-16	7/16"		
54P-1FO9-06-06	ORFSM X SAEM-90-06-06 FF6801-06-06	11/16"-16	9/16"		
54P-1FO9-06-08	ORFSM X SAEM-90-06-08 FF6801-06-08	11/16"-16	3/4"		
54P-1FO9-06-10	ORFSM X SAEM-90-06-10 FF6801-06-10	11/16"-16	7/8"		
54P-1FO9-08-06	ORFSM X SAEM-90-08-06 FF6801-08-06	13/16"-16	9/16"		
54P-1FO9-08-08	ORFSM X SAEM-90-08-08 FF6801-08-08	13/16"-16	3/4"		
54P-1FO9-08-10	ORFSM X SAEM-90-08-10 FF6801-08-10	13/16"-16	7/8"		
54P-1FO9-08-12	ORFSM X SAEM-90-08-12 FF6801-08-12	13/16"-16	1 1/16"		
54P-1FO9-10-08	ORFSM X SAEM-90-10-08 FF6801-10-08	1" -14	7/8"		
54P-1FO9-10-10	ORFSM X SAEM-90-10-10 FF6801-10-10	1" -14	7/8"		
54P-1FO9-10-12	ORFSM X SAEM-90-10-12 FF6801-10-12	1"-14	1 1/16"		
54P-1FO9-12-08	ORFSM X SAEM-90-12-08 FF6801-12-08	1 3/16"-10	3/4"		
54P-1FO9-12-10	ORFSM X SAEM-90-12-10 FF6801-12-10	1 3/16"-10	7/8"		
54P-1FO9-12-12	ORFSM X SAEM-90-12-12 FF6801-12-12	1 3/16"-12	1 1/16"		
54P-1FO9-12-16	ORFSM X SAEM-90-12-16 FF6801-12-16	1 3/16"-12	1 5/16"		
54P-1FO9-16-12	ORFSM X SAEM-90-16-12 FF6801-16-12	1 7/16"-12	1 1/16"		
54P-1FO9-16-16	ORFSM X SAEM-90-16-16 FF6801-16-16	1 7/16"-12	1 5/16"		

O.R.F.S ADAPTORS

Retail

Prices

ORFS MALE X ORFS FEMALE SWIVEL

19-09-2023

Part No	Description	Orfs	Orfs	Visual	Retail
54P-2F-06-04	ORFSM X ORFSF-06-04 FF2406-06-04	11/16"-16	9/16" -18		
54P-2F-08-04	ORFSM X ORFSF-08-04 FF2406-08-04	13/16"-16	9/16" -18		
54P-2F-08-06	ORFSM X ORFSF-08-06 FF2406-08-06	13/16"-16	11/16"-16		
54P-2F-10-12	ORFSM X ORFSF-10-12 FF2406-10-12	1"-14	1 3/16"-12		
54P-2F-10-16	ORFSM X ORFSF-10-16 FF2406-10-16	1"-14	1 7/16"-12		
54P-2F-12-08	ORFSM X ORFSF-12-08 FF2406-12-08	1 3/16"-12	13/16"-16		
54P-2F-12-10	ORFSM X ORFSF-12-10 FF2406-12-10	1 3/16"-12	1"-14		
54P-2F-16-08	ORFSM X ORFSF-16-08 FF2406-16-08	1 7/16"-12	13/16"-16		
54P-2F-16-12	ORFSM X ORFSF-16-12 FF2406-16-12	1 7/16"-12	1 3/16"-12		
54P-2F-20-16	ORFSM X ORFSF-20-16 FF2406-20-16	1 11/16" -12	1 7/16"-12		

ORFS MALE X ORFS FEMALE SWIVEL 45°

Part No	Description	Orfs	Orfs	Visual	Retail
54P-2F4-04	ORFSM X ORFSF-45-04-04 FF6502-04-04	9/16" -18	9/16" -18		
54P-2F4-06	ORFSM X ORFSF-45-06-06 FF6502-06-06	11/16" -16	11/16" -16		
54P-2F4-08	ORFSM X ORFSF-45-08-08 FF6502-08-08	13/16" -16	13/16" -16		
54P-2F4-10	ORFSM X ORFSF-45-10-10 FF6502-10-10	1" -14	1" -14		
54P-2F4-12	ORFSM X ORFSF-45-12-12 FF6502-12-12	1 3/16" -12	1 3/16" -12		
54P-2F4-16	ORFSM X ORFSF-45-16-16 FF6502-16-16	1 7/16" -12	1 7/16" -12		

ORFS MALE X ORFS FEMALE SWIVEL 90°

Part No	Description	Orfs	Orfs	Visual	Retail
54P-2F9-04	ORFSM X ORFSF-90-04-04 FF6500-04-04	9/16" -18	9/16" -18		
54P-2F9-06	ORFSM X ORFSF-90-06-06 FF6500-06-06	11/16" -16	11/16" -16		
54P-2F9-08	ORFSM X ORFSF-90-08-08 FF6500-08-08	13/16" -16	13/16" -16		
54P-2F9-10	ORFSM X ORFSF-90-10-10 FF6500-10-10	1" -14	1" -14		
54P-2F9-12	ORFSM X ORFSF-90-12-12 FF6500-12-12	1 3/16" -12	1 3/16" -12		
54P-2F9-16	ORFSM X ORFSF-90-16-16 FF6500-16-16	1 7/16" -12	1 7/16" -12		

ORFS MALE PLUG

Part No	Description	Orfs	Orfs	Visual	Retail
54P-4F-04	ORFS X HEX PLUG-04 FF2408-04	9/16" -18			
54P-4F-06	ORFS X HEX PLUG-06 FF2408-06	11/16" -16			
54P-4F-08	ORFS X HEX PLUG-08 FF2408-08	13/16" -16			
54P-4F-10	ORFS X HEX PLUG-10 FF2408-10	1" -14			
54P-4F-12	ORFS X HEX PLUG-12 FF2408-12	1 3/16" -12			
54P-4F-16	ORFS X HEX PLUG-16 FF2408-16	1 7/16" -12			
54P-4F-20	ORFS X HEX PLUG-20 FF2408-20	1 11/16"-12			
54P-4F-24	ORFS X HEX PLUG-24 FF2408-24	2"-12			

ORFS BULKHEAD WITH LOCKNUT

Part No	Description	Orfs	Orfs	Visual	Retail
54P-6F-LN-04	ORFSM X BULKHEAD-04 FF2700-04-04	9/16" -18			
54P-6F-LN-06	ORFSM X BULKHEAD-06 FF2700-06-06	11/16" -16			
54P-6F-LN-08	ORFSM X BULKHEAD-08 FF2700-08-08	13/16" -16			
54P-6F-LN-10	ORFSM X BULKHEAD-10 FF2700-10-10	1" -14			
54P-6F-LN-12	ORFSM X BULKHEAD-12 FF2700-12-12	1 3/16" -12			
54P-6F-LN-16	ORFSM X BULKHEAD-16 FF2700-16-16	1 7/16" -12			

ORFS BULKHEAD LOCKNUT

Part No	Description	Orfs	Orfs	Visual	Retail
54P-8F-04	ORFS X LOCKNUT-04	9/16"			
54P-8F-06	ORFS X LOCKNUT-06	11/16"			
54P-8F-08	ORFS X LOCKNUT-08	13/16"			
54P-8F-10	ORFS X LOCKNUT-10	1-14"			
54P-8F-12	ORFS X LOCKNUT-12	1 3/16"			
54P-8F-16	ORFS X LOCKNUT-16	1 7/16"			
54P-8F-20	ORFS X LOCKNUT-20	1 11/16"			

O.R.F.S ADAPTORS

Retail

Prices

ORFS FEMALE CAP

19-07-2023

Part No	Description	Orfs		Visual	Retail
54P-9F-04	ORFS X HEX - CAP-04 FF304C-04	9/16" -18			
54P-9F-06	ORFS X HEX - CAP-06 FF304C-06	11/16" -16			
54P-9F-08	ORFS X HEX - CAP-08 FF304C-08	13/16" -16			
54P-9F-10	ORFS X HEX - CAP-10 FF304C-10	1" -14			
54P-9F-12	ORFS X HEX - CAP-12 FF304C-12	1 3/16" -12			
54P-9F-16	ORFS X HEX - CAP-16 FF304C-16	1 7/16" -12			
54P-9F-20	ORFS X HEX - CAP-20 FF304C-20	1 11/16" -12			
54P-9F-24	ORFS X HEX - CAP-24 FF304C-24	2" -12			

ORFS MALE TEE

Part No	Description	Orfs		Visual	Retail
54P-AF-04	ORFS X MALE X TEE-04	9/16"			
54P-AF-06	ORFS X MALE X TEE-06	11/16"			
54P-AF-08	ORFS X MALE X TEE-08	13/16"			
54P-AF-10	ORFS X MALE X TEE-10	1-14"			
54P-AF-12	ORFS X MALE X TEE-12	1 3/16"			
54P-AF-16	ORFS X MALE X TEE-16	1 5/16"			
54P-AF-20	ORFS X MALE X TEE-20	1 11/16"			

ORFS MALE X ORFS MALE X SAE MALE X RUN TEE

Part No	Description	Orfs	Sae	Visual	Retail
54P-AFFO-04	ORFS M/M X SAEM RUN T-04-04-04 FF6804	9/16" -18	7/16"		
54P-AFFO-06	ORFS M/M X SAEM RUN T-06-06-06 FF6804	11/16" -16	9/16"		
54P-AFFO-08	ORFS M/M X SAEM RUN T-08-08-08 FF6804	13/16" -16	3/4"		
54P-AFFO-10	ORFS M/M X SAEM RUN T-10-10-10 FF6804	1" -14	7/8"		
54P-AFFO-12	ORFS M/M X SAEM RUN T-12-12-12 FF6804	1 3/16" -12	1 1/16"		
54P-AFFO-16	ORFS M/M X SAEM RUN T-16-16-16 FF6804	1 7/16" -12	1 7/16" -12		

ORFS MALE X SAE MALE X BRANCH TEE

Part No	Description	Orfs	Sae	Visual	Retail
54P-AFOF-04	ORFSM X SAEM X BRANCH-T-04-04-04 FF6803	9/16" -18	7/16"		
54P-AFOF-06	ORFSM X SAEM X BRANCH-T-06-06-06 FF6803	11/16" -16	9/16"		
54P-AFOF-08	ORFSM X SAEM X BRANCH-T-08-08-08 FF6803	13/16" -16	3/4"		
54P-AFOF-10	ORFSM X SAEM X BRANCH-T-10-10-10 FF6803	1" -14	7/8"		
54P-AFOF-12	ORFSM X SAEM X BRANCH-T-12-12-12 FF6803	1 3/16" -12	1 1/16"		

ORFS MALE X ORFS FEMALE BRANCH TEE

Part No	Description	Orfs		Visual	Retail
54P-BF-04	ORFS M/M/F BRANCH-T-04 FF6600-04-04-04	9/16" -18			
54P-BF-06	ORFS M/M/F BRANCH-T-06 FF6600-06-06-06	11/16" -16			
54P-BF-08	ORFS M/M/F BRANCH-T-08 FF6600-08-08-08	13/16" -16			
54P-BF-10	ORFS M/M/F BRANCH-T-10 FF6600-10-10-10	1" -14			
54P-BF-12	ORFS M/M/F BRANCH-T-12 FF6600-12-12-12	1 3/16" -12			
54P-BF-16	ORFS M/M/F BRANCH-T-16 FF6600-16-16-16	1 7/16" -12			

ORFS MALE X ORFS FEMALE RUN TEE

Part No	Description	Orfs		Visual	Retail
54P-CF-04	ORFSM X ORFSF X RUN-T-04 FF6602-04-04-04	9/16" -18			
54P-CF-06	ORFSM X ORFSF X RUN-T-06 FF6602-06-06-06	11/16" -16			
54P-CF-08	ORFSM X ORFSF X RUN-T-08 FF6602-08-08-08	13/16" -16			
54P-CF-10	ORFSM X ORFSF X RUN-T-10 FF6602-10-10-10	1" -14			
54P-CF-12	ORFSM X ORFSF X RUN-T-12 FF6602-12-12-12	1 3/16" -12			
54P-CF-16	ORFSM X ORFSF X RUN-T-16 FF6602-16-16-16	1 7/16" -12			

S.A.E. ADAPTORS

Retail

Prices

SAE MALE PLUG HEX

30-03-2023

Part No	Description	Sae	Sae	Visual	Retail
54P-4O-04	SAE O RING-PLUG-HEX-04 6408-04	7/16"			
54P-4O-05	SAE O RING-PLUG-HEX-05 6408-05	1/2"			
54P-4O-06	SAE O RING-PLUG-HEX-06 6408-06	9/16"			
54P-4O-08	SAE O RING-PLUG-HEX-08 6408-08	3/4"			
54P-4O-10	SAE O RING-PLUG-HEX-10 6408-10	7/8"			
54P-4O-12	SAE O RING-PLUG-HEX-12 6408-12	1 1/16"			
54P-4O-14	SAE O RING-PLUG-HEX-14 6408-14	1 3/16"			
54P-4O-16	SAE O RING-PLUG-HEX-16 6408-16	1 5/16"			
54P-4O-20	SAE O RING-PLUG-HEX-20 6408-20	1 5/8"			
54P-4O-24	SAE O RING-PLUG-HEX-24 6408-24	1 7/8"			
54P-4O-32	SAE O RING-PLUG-HEX-32 6408-32	2 1/2"			

SAE MALE PLUG INHEX

Part No	Description	Sae	Sae	Visual	Retail
54P-4ON-04	SAE O MALE-INHEX-04 2408-04	7/16"			
54P-4ON-05	SAE O MALE-INHEX-05 2408-05	1/2"			
54P-4ON-06	SAE O MALE-INHEX-06 2408-06	9/16"			
54P-4ON-08	SAE O MALE-INHEX-08 2408-08	3/4"			
54P-4ON-10	SAE O MALE-INHEX-10 2408-10	7/8"			
54P-4ON-12	SAE O MALE-INHEX-12 2408-12	1 1/16"			
54P-4ON-16	SAE O MALE-INHEX-16 2408-16	1 5/16"			
54P-4ON-20	SAE O MALE-INHEX-20 2408-20	1 5/8"			
54P-4ON-24	SAE O MALE-INHEX-24 2408-24	1 7/8"			

SAE MALE X NPT FEMALE FIXED

Part No	Description	Sae	Npt	Visual	Retail	
54P-5ON-04-04	SAE O MALE X NPT FEMALE FIXED-04-04	7/16"	1/4"			
54P-5ON-04-06	SAE O MALE X NPT FEMALE FIXED-04-06	7/16"	3/8"			
54P-5ON-05-02	SAE O MALE X NPT FEMALE FIXED-05-02	1/2"-20	1/8"			
54P-5ON-06	SAE O MALE X NPT FEMALE FIXED-06-06	9/16"	3/8"			
54P-5ON-06-04	SAE O MALE X NPT FEMALE FIXED-06-04	9/16"	1/4"			
54P-5ON-08	SAE O MALE X NPT FEMALE FIXED-08-08	3/4"-16	1/2"			
54P-5ON-08-04	SAE O MALE X NPT FEMALE FIXED-08-04	3/4"-16	1/4"			
54P-5ON-08-06	SAE O MALE X NPT FEMALE FIXED-08-06	3/4"	3/8"			
54P-5ON-08-12	SAE O MALE X NPT FEMALE FIXED-08-12	3/4"-16	3/4"			
54P-5ON-10-06	SAE O MALE X NPT FEMALE FIXED-10-06	7/8"	3/8"			
54P-5ON-10-08	SAE O MALE X NPT FEMALE FIXED-10-08	7/8"	1/2"			
54P-5ON-12	SAE O MALE X NPT FEMALE FIXED-12-12	1 1/16"	3/4"			
54P-5ON-12-08	SAE O MALE X NPT FEMALE FIXED-12-08	1 1/16"	1/2"			
54P-5ON-12-16	SAE O MALE X NPT FEMALE FIXED-12-16	1 1/16"	1"			
54P-5ON-16	SAE O MALE X NPT FEMALE FIXED-16-16	1 5/16"	1"			
54P-5ON-16-08	SAE O MALE X NPT FEMALE FIXED-16-08	1 5/16"	1/2"			
54P-5ON-16-12	SAE O MALE X NPT FEMALE FIXED-16-12	1 5/16"	3/4"			
54P-5ON-20-16	SAE O MALE X NPT FEMALE FIXED-20-16	1 5/8"	1"			

FLANGE ADAPTORS

Retail

Prices

3000 SPLIT FLANGE

30-03-2023

Part No	Description	E	C	Bolt	Visual	Retail
54P-FL-08	SPLIT FLANGE-3-08 SF3000-08	17.5	38.1	M8X25		
54P-FL-12	SPLIT FLANGE-3-12 SF3000-12	22.2	47.6	M10X30		
54P-FL-16	SPLIT FLANGE-3-16 SF3000-16	26.2	52.4	M10X30		
54P-FL-20	SPLIT FLANGE-3-20 SF3000-20	30.2	58.7	M10X30		
54P-FL-24	SPLIT FLANGE-3-24 SF3000-24	35.7	69.9	M12X35		
54P-FL-32	SPLIT FLANGE-3-32 SF3000-32	42.9	77.8	M12X35		
54P-FL-40	SPLIT FLANGE-3-40 SF3000-40	50.8	88.9	M12X40		

6000 SPLIT FLANGE

Part No	Description	E	C	Bolt	Visual	Retail
54P-FS-08	SPLIT FLANGE-6-08 SF6000-08	18.2mm	40.5mm	M8X30		
54P-FS-12	SPLIT FLANGE-6-12 SF6000-12	23.8mm	50.8mm	M10X35		
54P-FS-16	SPLIT FLANGE-6-16 SF6000-16	27.8mm	57.2mm	M12X45		
54P-FS-20	SPLIT FLANGE-6-20 SF6000-20	31.8mm	66.7mm	M14X50		
54P-FS-24	SPLIT FLANGE-6-24 SF6000-24	36.6mm	97.4mm	M16X55		
54P-FS-32	SPLIT FLANGE-6-32 SF6000-32	44.4mm	96.8mm	M20X70		

3000 SOLID FLANGE

Part No	Description	E	C	Bolt	Visual	Retail
54P-S-B-FL-08	SOLID FLANGE -3-08 SF3000-08	17.5	38.1	M8X25		
54P-S-B-FL-12	SOLID FLANGE -3-12 SF3000-12	22.2	47.6	M10X30		
54P-S-B-FL-16	SOLID FLANGE -3-16 SF3000-16	26.2	52.4	M10X30		
54P-S-B-FL-20	SOLID FLANGE -3-20 SF3000-20	30.2	58.7	M10X30		
54P-S-B-FL-24	SOLID FLANGE -3-24 SF3000-24	35.7	69.9	M12X35		
54P-S-B-FL-32	SOLID FLANGE -3-32 SF3000-32	42.9	77.8	M12X35		
54P-S-B-FL-40	SOLID FLANGE -3-40 SF3000-40	50.8	88.9	M12X40		

6000 SOLID FLANGE

Part No	Description	E	C	Bolt	Visual	Retail
54P-S-B-FS-08	SOLID FLANGE -6-08 SF6000-08	18.2mm	40.5mm	M8X30		
54P-S-B-FS-12	SOLID FLANGE -6-12 SF6000-12	23.8mm	50.8mm	M10X35		
54P-S-B-FS-16	SOLID FLANGE -6-16 SF6000-16	27.8mm	57.2mm	M12X45		
54P-S-B-FS-20	SOLID FLANGE -6-20 SF6000-20	31.8mm	66.7mm	M14X50		
54P-S-B-FS-24	SOLID FLANGE -6-24 SF6000-24	36.6mm	97.4mm	M16X55		
54P-S-B-FS-32	SOLID FLANGE -6-32 SF6000-32	44.4mm	96.8mm	M20X70		

3000 PORT ADAPTOR SAE O'RING FLANGE TO BSPP

Part No	Description	E	C	Bolt	Visual	Retail
54P-SGF3-08G08	PORT ADAPTOR 3000 1/2" BSPP	17.5	38.1	M8X25		
54P-SGF3-12G12	PORT ADAPTOR 3000 3/4" BSPP	22.2	47.6	M10X30		
54P-SGF3-16G16	PORT ADAPTOR 3000 1" BSPP	26.2	52.4	M10X30		
54P-SGF3-20G20	PORT ADAPTOR 3000 1-1/4" BSPP	30.2	58.7	M10X30		
54P-SGF3-24G24	PORT ADAPTOR 3000 1-1/2" BSPP	35.7	69.9	M12X35		
54P-SGF3-32G32	PORT ADAPTOR 3000 2" BSPP	42.9	77.8	M12X35		
54P-SGF3-40G40	PORT ADAPTOR 3000 2-1/2" BSPP	50.8	88.9	M12X40		

6000 PORT ADAPTOR SAE O'RING FLANGE TO BSPP

Part No	Description	E	C	Bolt	Visual	Retail
54P-SGF6-08G08	PORT ADAPTOR 6000 1/2" BSPP	18.2mm	40.5mm	M8X30		
54P-SGF6-12G12	PORT ADAPTOR 6000 3/4" BSPP	23.8mm	50.8mm	M10X35		
54P-SGF6-16G16	PORT ADAPTOR 6000 1" BSPP	27.8mm	57.2mm	M12X45		
54P-SGF6-20G20	PORT ADAPTOR 6000 1-1/4" BSPP	31.8mm	66.7mm	M14X50		
54P-SGF6-24G24	PORT ADAPTOR 6000 1-1/2" BSPP	36.6mm	97.4mm	M16X55		
54P-SGF6-32G32	PORT ADAPTOR 6000 2" BSPP	44.4mm	96.8mm	M20X70		

BANJO ADAPTORS

Retail

Prices

BOLT FOR BANJO BSP

01-10-2022

Part No	Description	Bsp	Bsp	Visual	Retail
54P-RV431-0400	1/4" BSP BOLT FOR BANJO	1/4"			
54P-RV431-0600	3/8" BSP BOLT FOR BANJO	3/8"			
54P-RV431-0800	1/2" BSP BOLT FOR BANJO	1/2"			
54P-RV431-1200	3/4" BSP BOLT FOR BANJO	3/4"			
54P-RV431-1600	1" BSP BOLT FOR BANJO	1"			

THREADED BANJO BSP

Part No	Description	Bsp	Bsp	Visual	Retail
54P-RV454-0404	1/4" BSP THREADED BANJO	1/4"			
54P-RV454-0606	3/8" BSP THREADED BANJO	3/8"			
54P-RV454-0806	1/2"-3/8" BSP THREADED BANJO	1/2"	3/8"		
54P-RV454-0808	1/2" BSP THREADED BANJO	1/2"			
54P-RV454-1208	3/4"-1/2" BSP THREADED BANJO	3/4"	1/2"		
54P-RV454-1212	3/4" BSP THREADED BANJO	3/4"			
54P-RV454-1616	1" BSP THREADED BANJO	1"			

MALE THREADED PORT WELDABLE

Part No	Description	Bsp	Bsp	Visual	Retail
54P-RV511-0400	1/4" BSP WELDABLE MALE	1/4"			
54P-RV511-0600	3/8" BSP WELDABLE MALE	3/8"			
54P-RV511-0800	1/2" BSP WELDABLE MALE	1/2"			
54P-RV511-1200	3/4" BSP WELDABLE MALE	3/4"			
54P-RV511-1600	1" BSP WELDABLE MALE	1"			
54P-RV511-2000	1 1/4" BSP WELDABLE MALE	1 1/4"			

FEMALE THREADED PORT WELDABLE

Part No	Description	Bsp	Bsp	Visual	Retail
54P-CBS0300000	THREADED PORT BSP 1/8" L14 X OD20	1/8"			
54P-CBS0400000	THREADED PORT BSP 1/4" L16 X OD22	1/4"			
54P-CBS0600000	THREADED PORT BSP 3/8" L17 X OD26	3/8"			
54P-CBS0800000	THREADED PORT BSP 1/2" L18 X OD30	1/2"			
54P-CBS1200000	THREADED PORT BSP 3/4" L20 X OD38	3/4"			
54P-CBS1600000	THREADED PORT BSP 1" L25 X OD45	1"			
54P-CBS2000000	THREADED PORT BSP 1 1/4" L24,5 X OD55	1 1/4"			
54P-CBS2400000	THREADED PORT BSP 1 1/2" L30 X OD60	1 1/2"			
54P-CBS3200000	THREADED PORT BSP 2" L30 X OD70	2"			

DOWTY WASHERS & TEST POINTS

Retail

Prices

IMPERIAL

19-07-2023

Part No	Description	Thread	Visual	Retail
54P-DW-02	1/8" BONDED WASHER	1/8"		
54P-DW-04	1/4" BONDED WASHER	1/4"		
54P-DW-06	3/8" BONDED WASHER	3/8"		
54P-DW-08	1/2" BONDED WASHER	1/2"		
54P-DW-10	5/8" BONDED WASHER	5/8"		
54P-DW-12	3/4" BONDED WASHER	3/4"		
54P-DW-16	1" BONDED WASHER	1"		
54P-DW-20	1 1/4" BONDED WASHER	1 1/4"		
54P-DW-24	1 1/2" BONDED WASHER	1 1/2"		
54P-DW-32	2" BONDED WASHER	2"		

METRIC

Part No	Description	Thread	Visual	Retail
54P-DW-06M	6mm BONDED WASHER	6mm		
54P-DW-08M	8mm BONDED WASHER	8mm		
54P-DW-10M	10mm BONDED WASHER	10mm		
54P-DW-12M	12mm BONDED WASHER	12mm		
54P-DW-14M	14mm BONDED WASHER	14mm		
54P-DW-16M	16mm BONDED WASHER	16mm		
54P-DW-18M	18mm BONDED WASHER	18mm		
54P-DW-20M	20mm BONDED WASHER	20mm		
54P-DW-22M	22mm BONDED WASHER	22mm		
54P-DW-24M	24mm BONDED WASHER	24mm		
54P-DW-26M	26mm BONDED WASHER	26mm		
54P-DW-30M	30mm BONDED WASHER	30mm		

GAUGE HOSE ASSEMBLIES & TEST POINTS

Part No	Description	Visual	Retail
54P-MMH-64001	0/700 Bar 1/4" BSPP M16X2 1000 mm		
54P-MMH-64001-5	0/700 Bar 1/4" BSPP M16X2 1500 mm		
54P-MMH-64002	0/700 Bar 1/4" BSPP M16X2 2500 mm		

MINI MESS

Part No	Description	Visual	Retail
54P-MMP-02R	MINI MESS POINT 1/8" BSPP		
54P-MMP-04R	MINI MESS POINT 1/4" BSPP		
54P-MMP-06R	MINI MESS POINT 3/8" BSPP		
54P-MMP-08R	MINI MESS POINT 1/2" BSPP		
54P-MMP-04N	MINI MESS POINT 1/4" NPT		
54P-MMP-06N	MINI MESS POINT 3/8" NPT		

GAUGE ISOLATOR

Part No	Description	Visual	Retail
66H-DFPE1G0400	1/4" GAUGE ISOLATOR		

QUICK COUPLERS

Retail

Prices

BSPP MALE PIN - TYPE QUICK COUPLERS (ISO - 7241 A)

01-10-2022

Part No	Description	Bspp	W/Press	Visual	Retail
55P-HFSFP7514	1/4" BSPP MALE PIN - TYPE Q-C	1/4"	350Bar		
55P-HFSFP7538	3/8" BSPP MALE PIN - TYPE Q-C	3/8"	315Bar		
55P-HFSFP7512	1/2" BSPP MALE PIN - TYPE Q-C	1/2"	250Bar		
55P-HFSFP7534	3/4" BSPP MALE PIN - TYPE Q-C	3/4"	250Bar		
55P-HFSFP7510	1" BSPP MALE PIN - TYPE Q-C	1"	230Bar		
55P-HFSFP75114	1 1/4" BSPP MALE PIN - TYPE Q-C	1 1/4"	230Bar		
55P-HFSFP75112	1 1/2" BSPP MALE PIN - TYPE Q-C	1 1/2"	180Bar		

BSPP FEMALE PIN - TYPE QUICK COUPLERS (ISO - 7241 A)

Part No	Description	Bspp	W/Press	Visual	Retail
55P-HFSFC7514	1/4" BSPP FEMALE PIN - TYPE Q-C	1/4"	350Bar		
55P-HFSFC7538	3/8" BSPP FEMALE PIN - TYPE Q-C	3/8"	315Bar		
55P-HFSFC7512	1/2" BSPP FEMALE PIN - TYPE Q-C	1/2"	250Bar		
55P-HFSFC7534	3/4" BSPP FEMALE PIN - TYPE Q-C	3/4"	250Bar		
55P-HFSFC7510	1" BSPP FEMALE PIN - TYPE Q-C	1"	230Bar		
55P-HFSFC75114	1 1/4" BSPP FEMALE PIN - TYPE Q-C	1 1/4"	230Bar		
55P-HFSFC75112	1 1/2" BSPP FEMALE PIN - TYPE Q-C	1 1/2"	180Bar		

BSPP MALE BALL - TYPE QUICK COUPLERS (ISO - 7241 A)

Part No	Description	Bspp	W/Press	Visual	Retail
55P-HFSFP6814	1/4" BSPP MALE BALL - TYPE Q-C	1/4"	207Bar		
55P-HFSFP6838	3/8" BSPP MALE BALL - TYPE Q-C	3/8"	207Bar		
55P-HFSFP6812	1/2" BSPP MALE BALL - TYPE Q-C	1/2"	207Bar		
55P-HFSFP6834	3/4" BSPP MALE BALL - TYPE Q-C	3/4"	170Bar		
55P-HFSFP6810	1" BSPP MALE BALL - TYPE Q-C	1"	150Bar		
55P-HFSFP68114	1 1/4" BSPP MALE BALL - TYPE Q-C	1 1/4"	100Bar		
55P-HFSFP68112	1 1/2" BSPP MALE BALL - TYPE Q-C	1 1/2"	70Bar		

BSPP FEMALE BALL - TYPE QUICK COUPLERS (ISO - 7241 A)

Part No	Description	Bspp	W/Press	Visual	Retail
55P-HFSFC6814	1/4" BSPP FEMALE BALL - TYPE Q-C	1/4"	207Bar		
55P-HFSFC6838	3/8" BSPP FEMALE BALL - TYPE Q-C	3/8"	207Bar		
55P-HFSFC6812	1/2" BSPP FEMALE BALL - TYPE Q-C	1/2"	207Bar		
55P-HFSFC6834	3/4" BSPP FEMALE BALL - TYPE Q-C	3/4"	170Bar		
55P-HFSFC6810	1" BSPP FEMALE BALL - TYPE Q-C	1"	150Bar		
55P-HFSFC68114	1 1/4" BSPP FEMALE BALL - TYPE Q-C	1 1/4"	100Bar		
55P-HFSFC68112	1 1/2" BSPP FEMALE BALL - TYPE Q-C	1 1/2"	70Bar		

BSPP MALE FLAT FACE - TYPE QUICK COUPLERS (ISO - 16028)

Part No	Description	Bspp	W/Press	Visual	Retail
55P-HFSFP9612	1/2" BSPP MALE FLAT FACE - TYPE Q-C	1/2"	330 Bar		
55P-HFSFP9634	3/4" BSPP MALE FLAT FACE - TYPE Q-C	3/4"	330 Bar		

BSPP FEMALE FLAT FACE - TYPE QUICK COUPLERS (ISO - 16028)

Part No	Description	Bspp	W/Press	Visual	Retail
55P-HFSFC9612	1/2" BSPP FEMALE FLAT FACE - TYPE Q-C	1/2"	330 Bar		
55P-HFSFC9634	3/4" BSPP FEMALE FLAT FACE - TYPE Q-C	3/4"	330 Bar		

HYDRAULIC PLASTIC PLUGS

INTERNAL TAPER PLUG

BSP

Retail
Prices
01-10-2022

Part No	Description	(A)	(B)	(C)	(D)	(E)	(F)	Visual	MIN QTY	Retail
58P-PPT-1004	1/8"	7.6	9.3	6.0	7.7	9.6	12.7		100	
58P-PPT-1008	1/4"	10.6	12.3	9.0	10.7	9.6	16.0		100	
58P-PPT-1012	3/8"	14.0	16.0	12.4	14.4	11.9	19.1		100	
58P-PPT-1016	1/2"	17.5	20.0	15.9	18.4	14.2	23.9		100	
58P-PPT-1019	5/8"	20.4	23.1	18.8	21.6	16.0	26.9		100	
58P-PPT-1021	3/4"	23.2	26.4	21.7	24.9	17.5	29.5		100	
58P-PPT-1024	1"	29.9	32.6	28.3	31.0	16.0	36.6		50	
58P-PPT-1027	1 1/4"	36.8	40.6	35.2	39.0	22.3	44.5		50	
58P-PPT-1030	1 1/2"	44.5	47.7	42.9	46.2	19.1	50.8		50	
58P-PPT-1040	2"	54.0	61.1	52.4	59.5	25.4	64.3		20	

NPT

Part No	Description	(A)	(B)	(C)	(D)	(E)	(F)	Visual	MIN QTY	Retail
58P-PPT-1004	1/8"	7.6	9.3	6.0	7.7	9.6	12.7		100	
58P-PPT-1008	1/4"	10.6	12.3	9.0	10.7	9.6	16.0		100	
58P-PPT-1012	3/8"	14.0	16.0	12.4	14.4	11.9	19.1		100	
58P-PPT-1016	1/2"	17.5	20.0	15.9	18.4	14.2	23.9		100	
58P-PPT-1021	3/4"	23.2	26.4	21.7	24.9	17.5	29.5		100	
58P-PPT-1024	1"	29.9	32.6	28.3	31.0	16.0	36.6		50	
58P-PPT-1027	1 1/4"	36.8	40.6	35.2	39.0	22.3	44.5		50	
58P-PPT-1030	1 1/2"	44.5	47.7	42.9	46.2	19.1	50.8		50	
58P-PPT-1040	2"	54.0	61.1	52.4	59.5	25.4	64.3		20	

SAE "O"

Part No	Description	(A)	(B)	(C)	(D)	(E)	(F)	Visual	MIN QTY	Retail
58P-PPT-1007	1/4"	8.4	10.1	6.8	8.5	9.6	13.5		100	
58P-PPT-1008	5/16"	10.6	12.3	9.0	10.7	9.6	16.0		100	
58P-PPT-1010	3/8"	12.0	13.9	10.4	12.3	11.2	17.5		100	
58P-PPT-1014	1/2"	16.3	18.5	14.7	16.9	12.7	22.3		100	
58P-PPT-1018	5/8"	19.1	21.5	17.5	19.9	14.2	25.4		100	
58P-PPT-1021	3/4"	23.2	26.4	21.7	24.9	17.5	29.5		100	
58P-PPT-1024	1"	29.9	32.6	28.3	31.0	16.0	36.6		50	
58P-PPT-1027	1 1/4"	36.8	40.6	35.2	39.0	22.3	44.5		50	
58P-PPT-1030	1 1/2"	44.5	47.7	42.9	46.2	19.1	50.8		50	
58P-PPT-1043	2"	58.4	62.6	56.8	61.0	25.4	66.8		20	

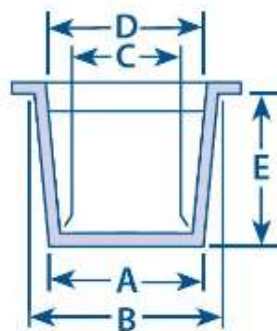
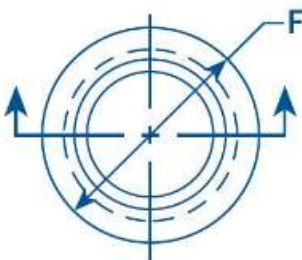

HYDRAULIC PLASTIC PLUGS

INTERNAL TAPER PLUG

BOSCH

Retail

Prices

01-10-2022

Part No	Description	(A)	(B)	(C)	(D)	(E)	(F)	Visual	MIN QTY	Retail
58P-PPT-1004	8	7.6	9.3	6.0	7.7	9.6	12.7		100	
58P-PPT-1008	12	10.6	12.3	9.0	10.7	9.6	16.0		100	
58P-PPT-1012	15	14.0	16.0	12.4	14.4	11.9	19.1		100	
58P-PPT-1016	18	17.5	20.0	15.9	18.4	14.2	23.9		100	
58P-PPT-1018	20	19.1	21.5	17.5	19.9	14.2	25.4		100	
58P-PPT-1021	26	23.2	26.4	21.7	24.9	17.5	29.5		100	

DIAMOND

Part No	Description	(A)	(B)	(C)	(D)	(E)	(F)	Visual	MIN QTY	Retail
58P-PPT-1010	13	12.0	13.9	10.4	12.3	11.2	17.5		100	
58P-PPT-1016	19	17.5	20.0	15.9	18.4	14.2	23.9		100	
58P-PPT-1022	27	25.3	29.1	23.7	27.5	19.1	33.3		100	
58P-PPT-1026	34	33.3	37.2	31.7	35.6	22.3	41.4		50	
58P-PPT-1026	36	33.3	37.2	31.7	35.6	22.3	41.4		50	
58P-PPT-1030	45	44.5	47.7	42.9	46.2	19.1	50.8		50	

SF 3000

Part No	Description	(A)	(B)	(C)	(D)	(E)	(F)	Visual	MIN QTY	Retail
58P-PPT-1010	1/2"	12.0	13.9	10.4	12.3	11.2	17.5		100	
58P-PPT-1016	3/4"	17.5	20.0	15.9	18.4	14.2	23.9		100	
58P-PPT-1021	1"	23.2	26.4	21.7	24.9	17.5	29.5		100	
58P-PPT-1024	1 1/4"	29.9	32.6	28.3	31.0	16.0	36.6		50	
58P-PPT-1027	1 1/2"	36.8	40.6	35.2	39.0	22.3	44.5		50	
58P-PPT-1032	2"	48.3	52.7	46.7	51.1	25.4	57.2		50	
58P-PPT-1046	2 1/2"	58.6	67.3	57.0	65.7	31.8	70.6		20	

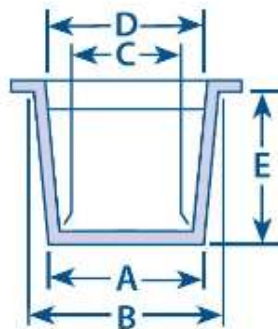
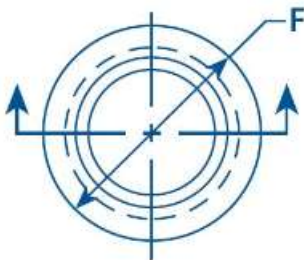

HYDRAULIC PLASTIC PLUGS

EXTERNAL USE TAPER PLUG

BSP MALE

Retail

Prices

01-10-2022

Part No	Description	(A)	(B)	(C)	(D)	(E)	(F)	Visual	MIN QTY	Retail
58P-PPT-1008	1/8"	10.6	12.3	9.0	10.7	9.6	16.0		100	
58P-PPT-1011	1/4"	13.5	15.4	11.9	13.8	11.2	19.1		100	
58P-PPT-1015	3/8"	17.2	19.2	15.6	17.6	12.7	22.3		100	
58P-PPT-1019	1/2"	20.4	23.1	18.8	21.6	16.0	26.9		100	
58P-PPT-1021	5/8"	23.2	26.4	21.7	24.9	17.5	29.5		100	
58P-PPT-1022	3/4"	25.3	29.1	23.7	27.5	19.1	33.3		100	
58P-PPT-1026	1"	33.3	37.2	31.7	35.6	22.3	41.4		50	
58P-PPT-1027	1 1/4"	41.4	44.5	39.8	42.9	19.1	49.3		50	
58P-PPT-1032	1 1/2"	48.3	52.7	46.7	51.1	25.4	57.2		50	
58P-PPT-1040	2"	54.0	61.1	52.4	59.5	25.4	64.3		20	

JIC MALE

Part No	Description	(A)	(B)	(C)	(D)	(E)	(F)	Visual	MIN QTY	Retail
58P-PPT-1010	1/4"	12.0	13.9	10.4	12.3	11.2	17.5		100	
58P-PPT-1011	5/16"	13.5	15.4	11.9	13.8	11.2	19.1		100	
58P-PPT-1012	3/8"	14.0	16.0	12.4	14.4	11.9	19.1		100	
58P-PPT-1018	1/2"	19.1	21.5	17.5	19.9	14.2	25.4		100	
58P-PPT-1021	3/4"	23.2	26.4	21.7	24.9	17.5	29.5		100	
58P-PPT-1022	3/4"	25.3	29.1	23.7	27.5	19.1	33.3		100	
58P-PPT-1026	1"	33.3	37.2	31.7	35.6	22.3	41.4		50	
58P-PPT-1027	1 1/4"	41.4	44.5	39.8	42.9	19.1	49.3		50	
58P-PPT-1032	1 1/2"	48.3	52.7	46.7	51.1	25.4	57.2		50	
58P-PPT-1046	2"	58.6	67.3	57.0	65.7	31.8	70.6		20	

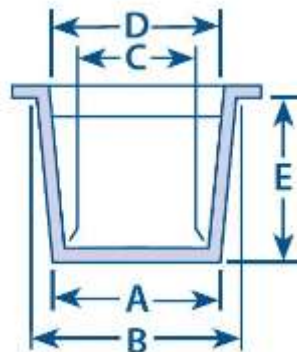
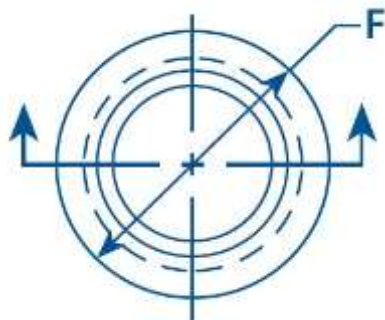

HYDRAULIC THREADED PLUG PORTS

Retail

INTERNAL

Prices

BSP

01-10-2022

Part No	Description	(d1)	(D)	(H)	(h1)	(S)	Visual	MIN QTY	Retail
58P-PPTH-BSP-04	1/4"	1/4" x 19	19.0	19.7	12.5	10.0		50	
58P-PPTH-BSP-06	3/8"	3/8" x 19	22.0	20.9	12.5	13.0		50	
58P-PPTH-BSP-08	1/2"	1/2" x 14	27.0	21.9	13.5	15.0		50	
58P-PPTH-BSP-10	5/8"	5/8"X14	29.5	21.9	13.5	17.0		-	
58P-PPTH-BSP-12	3/4"	3/4" x 14	32.0	21.9	13.5	19.0		50	
58P-PPTH-BSP-16	1"	1" x 11	40.0	23.6	15.0	24.0		25	
58P-PPTH-BSP-20	1-1/4"	1 1/4" x 11	50.0	23.6	15.0	24.0		20	
58P-PPTH-BSP-24	1-1/2"	1-1/2"X11	56.0	25.0	15.0	30.0		10	
58P-PPTH-BSP-32	2"	2"X11	68.0	25.0	15.0	36.0		10	

SAE "O"

Part No	Description	(d1)	(D)	(H)	(h1)	(S)	Visual	MIN QTY	Retail
58P-PPTH-SAE-04	1/4"	7/16"X20	16.0	19.7	12.5	10.0		50	
58P-PPTH-SAE-06	3/8"	9/16"X18	21.0	20.9	12.5	10.0		50	
58P-PPTH-SAE-08	1/2"	3/4"X16	27.0	21.9	13.5	13.0		50	
58P-PPTH-SAE-10	5/8"	7/8"X14	28.0	21.9	13.5	15.0		50	
58P-PPTH-SAE-12	3/4"	1-1/16X12	35.0	22.6	14.0	19.0		50	
58P-PPTH-SAE-16	1"	1-5/16"X12	42.0	24.0	14.0	24.0		25	
58P-PPTH-SAE-20	1-1/4"	1-5/8"X12	50.0	24.0	14.0	24.0		20	
58P-PPTH-SAE-24	1-1/2"	1-7/8"X12	55.0	24.0	14.0	30.0		10	

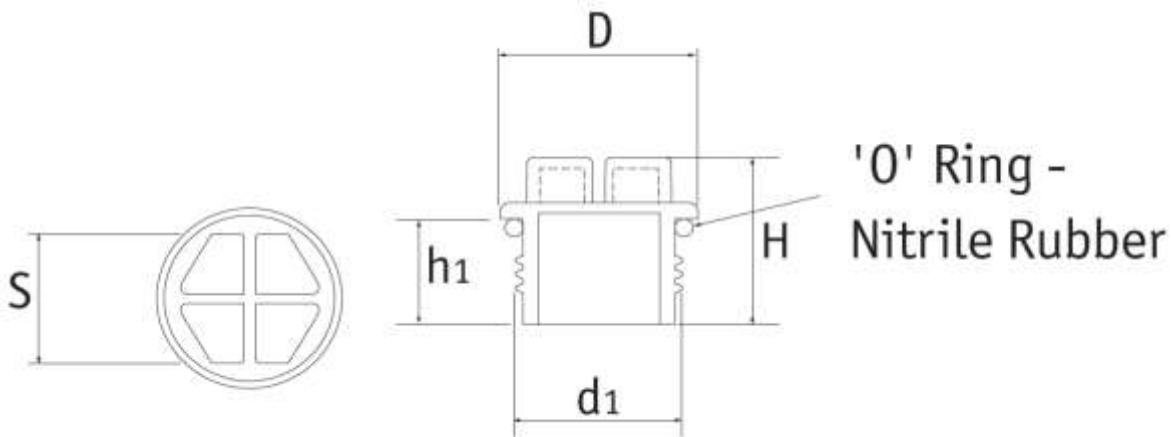

HYDRAULIC HOSE MACHINES

Retail

Prices

01-10-2022

BENCH CRIMPER 56P - SAM - P20

Part No	Description	Visual	Retail
56P-SAM-P20	MAX HOSE CRIMPING ; 1-1/2" 4SP		
	CRIMP RANGE ; 4 mm to 65 mm		
	MAX. OPENING ; +26 mm		
	ELECTRIC MOTOR ; SIEMENS		
	VOLTAGE ; 220V 4 POLE 50 Hz 3Kw		
	VOLTAGE ; 380V 4 POLE 50 Hz 3Kw		
	CRIMPING FORCE 1700 Kn		
	OPERATION ; BY HAND, BY FOOT, AUTO		
	DIE SETS MANUAL CHANGE		
	14 16 19 22 26 30 34 39 45		
	SIZE ; L 680 X W 600 X H 650		
	WEIGHT ; 220 Kg (no oil)		

BENCH CRIMPER 56P - SAM - P32

Part No	Description	Visual	Retail
56P-SAM-P32	MAX HOSE CRIMPING ; 2" 4SP		
	CRIMP RANGE ; 4 mm to 87 mm		
	MAX. OPENING ; +32 mm		
	ELECTRIC MOTOR ; SIEMENS		
	VOLTAGE ; 220V 4 POLE 50 Hz 3Kw		
	VOLTAGE ; 380V 4 POLE 50 Hz 4Kw		
	CRIMPING FORCE ; 2200 Kn		
	OPERATION ; BY HAND, BY FOOT, AUTO		
	DIE SETS ; MANUAL CHANGE ; mm		
	14 16 19 22 26 30 34 39 45 51 57 63 69		
	SIZE ; L 680 X W 595 X H 650		
	WEIGHT ; 250 Kg		

PEDESTAL CRIMPER 56P - SAM - P20Q

Part No	Description	Visual	Retail
56P-SAM-P20Q	MAX HOSE CRIMPING ; 1-1/2" 4SP		
	CRIMP RANGE ; 4 mm to 65 mm		
	MAX. OPENING ; +26 mm		
	ELECTRIC MOTOR ; SIEMENS		
	VOLTAGE ; 220V 4 POLE 50 Hz 3Kw		
	VOLTAGE ; 380V 4 POLE 50 Hz 3Kw		
	CRIMPING FORCE 1700 Kn		
	OPERATION ; BY HAND, BY FOOT, AUTO		
	DIE SETS QUICK CHANGE ; mm		
	14 16 19 22 26 30 34 39 45		
	SIZE ; L 680 X W 600 X H 1400		
	WEIGHT ; 270 Kg		

PEDESTAL CRIMPER 56P - SAM - P32Q

Part No	Description	Visual	Retail
56P-SAM-P32Q	MAX HOSE CRIMPING ; 2" 4SP		
	CRIMP RANGE ; 4 mm to 87 mm		
	MAX. OPENING ; +32 mm		
	ELECTRIC MOTOR ; SIEMENS		
	VOLTAGE ; 220V 4 POLE 50 Hz 3Kw		
	VOLTAGE ; 380V 4 POLE 50 Hz 4Kw		
	CRIMPING FORCE ; 2200 Kn		
	OPERATION ; BY HAND, BY FOOT, AUTO		
	DIE SETS QUICK CHANGE ; mm		
	14 16 19 22 26 30 34 39 45 51 57 63 69		
	SIZE ; L 680 X W 600 X H 1400		
	WEIGHT ; 300 Kg		

HYDRAULIC HOSE MACHINES

Retail

Prices

HAND CRIMPER 56P - SAM - P16HP

01-10-2022

Part No	Description	Visual	Retail
56P-SAM-P16HP	MAX HOSE CRIMPING ; 1" 2 WIRE		
	CRIMP RANGE ; 4 mm to 45 mm		
	MAX. OPENING ; +20 mm		
	HAND PUMP ; 700 BAR		
	CRIMPING FORCE 1000 Kn		
	CONTROL ; MICRO DIAL WITH LIGHT		
	DIE SETS MANUAL CHANGE		
	10 12 14 16 19 23 27 31		
	SIZE ; L 330 X W 400 X H 270		
	WEIGHT ; 25 Kg		

HAND CRIMPER 56P - SAM - P20HP

Part No	Description	Visual	Retail
56P-SAM-P20HP	MAX HOSE CRIMPING ; 1-1/2" 4SP		
	CRIMP RANGE ; 4 mm to 75 mm		
	MAX. OPENING ; +25 mm		
	HAND PUMP ; ENERPAC 700 BAR		
	CRIMPING FORCE 1400 Kn		
	CONTROL ; MICRO DIAL WITH LIGHT		
	DIE SETS MANUAL CHANGE		
	14 16 19 22 26 30 34 39 45		
	SIZE ; L 487 X W 440 X H 270		
	WEIGHT ; 55 Kg		

BENCH HOSE CUT - OFF 56P - SAM - C300

Part No	Description	Visual	Retail
56P-SAM-C300	HAND CUT-OFF MACHINE BENCH TOP		
	CUTTING RANGE ; 2" 4SP HOSE		
	VOLTAGE ; 220V 4 POLE 50 Hz 3Kw		
	VOLTAGE ; 380V 4 POLE 50 Hz 3Kw		
	POWER ; 3 Kw		
	WEIGHT ; 45 Kg		
	SIZE ; L 450 X W 400 X H 430		
	OPERATION ; HAND		
	APPLICATION ; 2 WIRE 4 WIRE		

PEDESTAL HOSE CUT - OFF 56P - SAM - C400

Part No	Description	Visual	Retail
56P-SAM-C400	CUT-OFF MACHINE WITH FOOT PEDAL		
	CUTTING RANGE ; 2" 4SP HOSE		
	VOLTAGE ; 220V 4 POLE 50 Hz 3Kw		
	VOLTAGE ; 380V 4 POLE 50 Hz 3Kw		
	POWER ; 3 Kw		
	WEIGHT ; 135 Kg		
	SIZE ; L 840 X W 550 X H 1150		
	OPERATION ; FOOT PEDAL CONTROL		
	APPLICATION ; 2 WIRE 4 WIRE		

STEEL TUBE FITTINGS

Retail

Prices

WELDABLE BOSSES

01-10-2022

Part No	Description		Visual	Retail
57P-AS-06L	WELDABLE BOSS 06 mm			
57P-AS-08L	WELDABLE BOSS 08 mm			
57P-AS-10L	WELDABLE BOSS 10 mm			
57P-AS-12L	WELDABLE BOSS 12 mm			
57P-AS-15L	WELDABLE BOSS 15 mm			
57P-AS-18L	WELDABLE BOSS 18 mm			
57P-AS-22L	WELDABLE BOSS 22 mm			
57P-AS-28L	WELDABLE BOSS 28 mm			
57P-AS-35L	WELDABLE BOSS 35 mm			
57P-AS-42L	WELDABLE BOSS 42 mm			
57P-AS-06S	WELDABLE BOSS 06 mm			
57P-AS-08S	WELDABLE BOSS 08 mm			
57P-AS-10S	WELDABLE BOSS 10 mm			
57P-AS-12S	WELDABLE BOSS 12 mm			
57P-AS-14S	WELDABLE BOSS 14 mm			
57P-AS-16S	WELDABLE BOSS 16 mm			
57P-AS-20S	WELDABLE BOSS 20 mm			
57P-AS-25S	WELDABLE BOSS 25 mm			
57P-AS-30S	WELDABLE BOSS 30 mm			
57P-AS-38S	WELDABLE BOSS 38 mm			

BLANKING PLUGS

Part No	Description		Visual	Retail	
57P-BUZ-06L-S	BLANKING PLUGS 06 mm				
57P-BUZ-08L-S	BLANKING PLUGS 08 mm				
57P-BUZ-10L-S	BLANKING PLUGS 10 mm				
57P-BUZ-12L-S	BLANKING PLUGS 12 mm				
57P-BUZ-15L-S	BLANKING PLUGS 15 mm				
57P-BUZ-18L-S	BLANKING PLUGS 18 mm				
57P-BUZ-22L-S	BLANKING PLUGS 22 mm				
57P-BUZ-28L-S	BLANKING PLUGS 28 mm				
57P-BUZ-35L-S	BLANKING PLUGS 35 mm				
57P-BUZ-42L-S	BLANKING PLUGS 42 mm				
57P-BUZ-14S	BLANKING PLUGS 14 mm				
57P-BUZ-16S	BLANKING PLUGS 16 mm				
57P-BUZ-20S	BLANKING PLUGS 20 mm				
57P-BUZ-25S	BLANKING PLUGS 25 mm				
57P-BUZ-30S	BLANKING PLUGS 30 mm				
57P-BUZ-38S	BLANKING PLUGS 38 mm				

STEEL TUBE FITTINGS				Retail
				Prices
CUTTING RINGS				01-10-2022
Part No	Description		Visual	Retail
57P-D-04LL	CUTTING RINGS 04 mm			
57P-D-06LL	CUTTING RINGS 06 mm			
57P-D-08LL	CUTTING RINGS 08 mm			
57P-D-16LL	CUTTING RINGS 16 mm			
57P-D-06L-S	CUTTING RINGS 06 mm			
57P-D-08L-S	CUTTING RINGS 08 mm			
57P-D-10L-S	CUTTING RINGS 10 mm			
57P-D-12L-S	CUTTING RINGS 12 mm			
57P-D-15L	CUTTING RINGS 15 mm			
57P-D-18L	CUTTING RINGS 18 mm			
57P-D-22L	CUTTING RINGS 22 mm			
57P-D-28L	CUTTING RINGS 28 mm			
57P-D-35L	CUTTING RINGS 35 mm			
57P-D-42L	CUTTING RINGS 42 mm			
57P-D-14S	CUTTING RINGS 14 mm			
57P-D-16S	CUTTING RINGS 16 mm			
57P-D-20S	CUTTING RINGS 20 mm			
57P-D-25S	CUTTING RINGS 25 mm			
57P-D-30S	CUTTING RINGS 30 mm			
57P-D-38S	CUTTING RINGS 38 mm			
WELD BULKHEADS				
Part No	Description		Visual	Retail
57P-ESV-06L	WELD BULKHEADS 06 mm			
57P-ESV-08L	WELD BULKHEADS 08 mm			
57P-ESV-10L	WELD BULKHEADS 10 mm			
57P-ESV-12L	WELD BULKHEADS 12 mm			
57P-ESV-15L	WELD BULKHEADS 15 mm			
57P-ESV-18L	WELD BULKHEADS 18 mm			
57P-ESV-22L	WELD BULKHEADS 22 mm			
57P-ESV-28L	WELD BULKHEADS 28 mm			
57P-ESV-35L	WELD BULKHEADS 35 mm			
57P-ESV-42L	WELD BULKHEADS 42 mm			
57P-ESV-06S	WELD BULKHEADS 06 mm			
57P-ESV-08S	WELD BULKHEADS 08 mm			
57P-ESV-10S	WELD BULKHEADS 10 mm			
57P-ESV-12S	WELD BULKHEADS 12 mm			
57P-ESV-14S	WELD BULKHEADS 14 mm			
57P-ESV-16S	WELD BULKHEADS 16 mm			
57P-ESV-20S	WELD BULKHEADS 20 mm			
57P-ESV-25S	WELD BULKHEADS 25 mm			
57P-ESV-30S	WELD BULKHEADS 30 mm			
57P-ESV-38S	WELD BULKHEADS 38 mm			
MANUFACTURED G.A.P. HYDRAULIC STEEL TUBE FITTINGS				PAGE G 2

STEEL TUBE FITTINGS

Retail

Prices

MALE BSP STANDPIPE

19-07-2023

Part No	Description	Visual	Retail
57P-EVGE06LR-ED	MALE BSP STANDPIPE 06 mm X 1/8"		
57P-EVGE08LR-ED	MALE BSP STANDPIPE 08 mm X 1/4"		
57P-EVGE10LR-ED	MALE BSP STANDPIPE 10 mm X 1/4"		
57P-EVGE12LR-ED	MALE BSP STANDPIPE 12 mm X 3/8"		
57P-EVGE15LR-ED	MALE BSP STANDPIPE 15 mm X 1/2"		
57P-EVGE18LR-ED	MALE BSP STANDPIPE 18 mm X 1/2"		
57P-EVGE22LR-ED	MALE BSP STANDPIPE 22 mm X 3/4"		
57P-EVGE28LR-ED	MALE BSP STANDPIPE 28 mm X 1"		
57P-EVGE35LR-ED	MALE BSP STANDPIPE 35 mm X 1 1/4"		
57P-EVGE42LR-ED	MALE BSP STANDPIPE 42 mm X 1 1/2"		
57P-EVGE06SR-ED	MALE BSP STANDPIPE 06 mm X 1/4"		
57P-EVGE08SR-ED	MALE BSP STANDPIPE 08 mm X 1/4"		
57P-EVGE10SR-ED	MALE BSP STANDPIPE 10 mm X 3/8"		
57P-EVGE12SR-ED	MALE BSP STANDPIPE 12 mm X 3/8"		
57P-EVGE14SR-ED	MALE BSP STANDPIPE 14 mm X 1/2"		
57P-EVGE16SR-ED	MALE BSP STANDPIPE 16 mm X 1/2"		
57P-EVGE20SR-ED	MALE BSP STANDPIPE 20 mm X 3/4"		
57P-EVGE25SR-ED	MALE BSP STANDPIPE 25 mm X 1"		
57P-EVGE30SR-ED	MALE BSP STANDPIPE 30 mm X 1 1/4"		
57P-EVGE38SR-ED	MALE BSP STANDPIPE 38 mm X 1 1/2"		

MALE NPT STANDPIPE

Part No	Description	Visual	Retail
57P-EVGE-06L	MALE NPT STANDPIPE 06mm X 1/8"		
57P-EVGE-08L	MALE NPT STANDPIPE 08mm X 1/4"		
57P-EVGE-10L	MALE NPT STANDPIPE 10mm X 1/4"		
57P-EVGE-12L	MALE NPT STANDPIPE 12mm X 3/8"		
57P-EVGE-15L	MALE NPT STANDPIPE 15mm X 1/2"		
57P-EVGE-18L	MALE NPT STANDPIPE 18mm X 1/2"		
57P-EVGE-22L	MALE NPT STANDPIPE 22mm X 3/4"		
57P-EVGE-28L	MALE NPT STANDPIPE 28mm X 1"		
57P-EVGE-35L	MALE NPT STANDPIPE 35mm X 1 1/4"		
57P-EVGE-42L	MALE NPT STANDPIPE 42mm X 1 1/2"		
57P-EVGE-06S	MALE NPT STANDPIPE 06mm X 1/4"		
57P-EVGE-08S	MALE NPT STANDPIPE 08mm X 1/4"		
57P-EVGE-10S	MALE NPT STANDPIPE 10mm X 3/8"		
57P-EVGE-12S	MALE NPT STANDPIPE 12mm X 3/8"		
57P-EVGE-14S	MALE NPT STANDPIPE 14mm X 1/2"		
57P-EVGE-16S	MALE NPT STANDPIPE 16mm X 1/2"		
57P-EVGE-20S	MALE NPT STANDPIPE 20mm X 3/4"		
57P-EVGE-25S	MALE NPT STANDPIPE 25mm X 1"		
57P-EVGE-30S	MALE NPT STANDPIPE 30mm X 1 1/4"		
57P-EVGE-38S	MALE NPT STANDPIPE 38mm X 1 1/2"		

STEEL TUBE FITTINGS

Retail

Prices

STANDPIPE RUN T SWIVEL L

19-07-2023

Part No	Description		Visual	Retail
57P-EVL-06L	STANDPIPE RUN T SWIVEL L 06 mm			
57P-EVL-08L	STANDPIPE RUN T SWIVEL L 08 mm			
57P-EVL-10L	STANDPIPE RUN T SWIVEL L 10 mm			
57P-EVL-12L	STANDPIPE RUN T SWIVEL L 12 mm			
57P-EVL-15L	STANDPIPE RUN T SWIVEL L 15 mm			
57P-EVL-18L	STANDPIPE RUN T SWIVEL L 18 mm			
57P-EVL-22L	STANDPIPE RUN T SWIVEL L 22 mm			
57P-EVL-28L	STANDPIPE RUN T SWIVEL L 28 mm			
57P-EVL-35L	STANDPIPE RUN T SWIVEL L 35 mm			
57P-EVL-42L	STANDPIPE RUN T SWIVEL L 42 mm			
57P-EVL-06S	STANDPIPE RUN T SWIVEL L 06 mm			
57P-EVL-08S	STANDPIPE RUN T SWIVEL L 08 mm			
57P-EVL-10S	STANDPIPE RUN T SWIVEL L 10 mm			
57P-EVL-12S	STANDPIPE RUN T SWIVEL L 12 mm			
57P-EVL-14S	STANDPIPE RUN T SWIVEL L 14 mm			
57P-EVL-16S	STANDPIPE RUN T SWIVEL L 16 mm			
57P-EVL-20S	STANDPIPE RUN T SWIVEL L 20 mm			
57P-EVL-25S	STANDPIPE RUN T SWIVEL L 25 mm			
57P-EVL-30S	STANDPIPE RUN T SWIVEL L 30 mm			
57P-EVL-38S	STANDPIPE RUN T SWIVEL L 38 mm			

STANDPIPE RUN T SWIVEL T

Part No	Description		Visual	Retail
57P-EVT-06L	STANDPIPE BRANCH T SWIVEL T 06 mm			
57P-EVT-08L	STANDPIPE BRANCH T SWIVEL T 08 mm			
57P-EVT-10L	STANDPIPE BRANCH T SWIVEL T 10 mm			
57P-EVT-12L	STANDPIPE BRANCH T SWIVEL T 12 mm			
57P-EVT-15L	STANDPIPE BRANCH T SWIVEL T 15 mm			
57P-EVT-18L	STANDPIPE BRANCH T SWIVEL T 18 mm			
57P-EVT-22L	STANDPIPE BRANCH T SWIVEL T 22 mm			
57P-EVT-28L	STANDPIPE BRANCH T SWIVEL T 28 mm			
57P-EVT-35L	STANDPIPE BRANCH T SWIVEL T 35 mm			
57P-EVT-42L	STANDPIPE BRANCH T SWIVEL T 42 mm			
57P-EVT-06S	STANDPIPE BRANCH T SWIVEL T 06 mm			
57P-EVT-08S	STANDPIPE BRANCH T SWIVEL T 08 mm			
57P-EVT-10S	STANDPIPE BRANCH T SWIVEL T 10 mm			
57P-EVT-12S	STANDPIPE BRANCH T SWIVEL T 12 mm			
57P-EVT-14S	STANDPIPE BRANCH T SWIVEL T 14 mm			
57P-EVT-16S	STANDPIPE BRANCH T SWIVEL T 16 mm			
57P-EVT-20S	STANDPIPE BRANCH T SWIVEL T 20 mm			
57P-EVT-25S	STANDPIPE BRANCH T SWIVEL T 25 mm			
57P-EVT-30S	STANDPIPE BRANCH T SWIVEL T 30 mm			
57P-EVT-38S	STANDPIPE BRANCH T SWIVEL T 38 mm			

STEEL TUBE FITTINGS

Retail

Prices

STANDPIPE SWIVEL ELBOWS

19-07-2023

Part No	Description		Visual	Retail
57P-EVW-06L	STANDPIPE SWIVEL ELBOWS 06 mm			
57P-EVW-08L	STANDPIPE SWIVEL ELBOWS 08 mm			
57P-EVW-10L	STANDPIPE SWIVEL ELBOWS 10 mm			
57P-EVW-12L	STANDPIPE SWIVEL ELBOWS 12 mm			
57P-EVW-15L	STANDPIPE SWIVEL ELBOWS 15 mm			
57P-EVW-18L	STANDPIPE SWIVEL ELBOWS 18 mm			
57P-EVW-22L	STANDPIPE SWIVEL ELBOWS 22 mm			
57P-EVW-28L	STANDPIPE SWIVEL ELBOWS 28 mm			
57P-EVW-35L	STANDPIPE SWIVEL ELBOWS 35 mm			
57P-EVW-42L	STANDPIPE SWIVEL ELBOWS 42 mm			
57P-EVW-06S	STANDPIPE SWIVEL ELBOWS 06 mm			
57P-EVW-08S	STANDPIPE SWIVEL ELBOWS 08 mm			
57P-EVW-10S	STANDPIPE SWIVEL ELBOWS 10 mm			
57P-EVW-12S	STANDPIPE SWIVEL ELBOWS 12 mm			
57P-EVW-14S	STANDPIPE SWIVEL ELBOWS 14 mm			
57P-EVW-16S	STANDPIPE SWIVEL ELBOWS 16 mm			
57P-EVW-20S	STANDPIPE SWIVEL ELBOWS 20 mm			
57P-EVW-25S	STANDPIPE SWIVEL ELBOWS 25 mm			
57P-EVW-30S	STANDPIPE SWIVEL ELBOWS 30 mm			
57P-EVW-38S	STANDPIPE SWIVEL ELBOWS 38 mm			

STRAIGHT CONNECTORS

Part No	Description		Visual	Retail
57P-G-04LL	STRAIGHT CONNECTORS 04 mm			
57P-G-06LL	STRAIGHT CONNECTORS 06 mm			
57P-G-08LL	STRAIGHT CONNECTORS 08 mm			
57P-G-16LL	STRAIGHT CONNECTORS 16 mm			
57P-G-06L	STRAIGHT CONNECTORS 06 mm			
57P-G-08L	STRAIGHT CONNECTORS 08 mm			
57P-G-09L	STRAIGHT CONNECTORS 09 mm			
57P-G-10L	STRAIGHT CONNECTORS 10 mm			
57P-G-11L	STRAIGHT CONNECTORS 11 mm			
57P-G-12L	STRAIGHT CONNECTORS 12 mm			
57P-G-15L	STRAIGHT CONNECTORS 15 mm			
57P-G-18L	STRAIGHT CONNECTORS 18 mm			
57P-G-22L	STRAIGHT CONNECTORS 22 mm			
57P-G-28L	STRAIGHT CONNECTORS 28 mm			
57P-G-35L	STRAIGHT CONNECTORS 35 mm			
57P-G-42L	STRAIGHT CONNECTORS 42 mm			
57P-G-06S	STRAIGHT CONNECTORS 06 mm			
57P-G-08S	STRAIGHT CONNECTORS 08 mm			
57P-G-10S	STRAIGHT CONNECTORS 10 mm			
57P-G-12S	STRAIGHT CONNECTORS 12 mm			
57P-G-14S	STRAIGHT CONNECTORS 14 mm			
57P-G-16S	STRAIGHT CONNECTORS 16 mm			
57P-G-20S	STRAIGHT CONNECTORS 20 mm			
57P-G-25S	STRAIGHT CONNECTORS 25 mm			
57P-G-30S	STRAIGHT CONNECTORS 30 mm			
57P-G-38S	STRAIGHT CONNECTORS 38 mm			

STEEL TUBE FITTINGS

Retail

Prices

FEMALE STUD COUPLINGS (BSPP) LR & SR SERIES

01-10-2022

Part No	Description	Visual	Retail
57P-GAI-06LR	FEMALE STUD COUPLINGS 06 mm X 1/8"		
57P-GAI-08LR	FEMALE STUD COUPLINGS 08 mm X 1/4"		
57P-GAI-10LR	FEMALE STUD COUPLINGS 10 mm X 1/4"		
57P-GAI-12LR	FEMALE STUD COUPLINGS 12 mm X 3/8"		
57P-GAI-15LR	FEMALE STUD COUPLINGS 15 mm X 1/2"		
57P-GAI-18LR	FEMALE STUD COUPLINGS 18 mm X 1/2"		
57P-GAI-22LR	FEMALE STUD COUPLINGS 22 mm X 3/4"		
57P-GAI-28LR	FEMALE STUD COUPLINGS 28 mm X 1"		
57P-GAI-35LR	FEMALE STUD COUPLINGS 35 mm X 1-1/4"		
57P-GAI-42LR	FEMALE STUD COUPLINGS 42 mm X 1-1/2"		
57P-GAI-06SR	FEMALE STUD COUPLINGS 06 mm X 1/4"		
57P-GAI-08SR	FEMALE STUD COUPLINGS 08 mm X 1/4"		
57P-GAI-10SR	FEMALE STUD COUPLINGS 10 mm X 3/8"		
57P-GAI-12SR	FEMALE STUD COUPLINGS 12 mm X 3/8"		
57P-GAI-14SR	FEMALE STUD COUPLINGS 14 mm X 1/2"		
57P-GAI-16SR	FEMALE STUD COUPLINGS 16 mm X 1/2"		
57P-GAI-20SR	FEMALE STUD COUPLINGS 20 mm X 3/4"		
57P-GAI-25SR	FEMALE STUD COUPLINGS 25 mm X 1"		
57P-GAI-30SR	FEMALE STUD COUPLINGS 30 mm X 1-1/4"		
57P-GAI-38SR	FEMALE STUD COUPLINGS 38 mm X 1-1/2"		

MALE STUD COUPLINGS NPT L SERIES

Part No	Description	Visual	Retail
57P-GE-06LN02	MALE STUD COUPLINGS 06mm X 1/8" NPT		
57P-GE-06LN04	MALE STUD COUPLINGS 06mm X 1/4" NPT		
57P-GE-08LN02	MALE STUD COUPLINGS 08mm X 1/8" NPT		
57P-GE-08LN04	MALE STUD COUPLINGS 08mm X 1/4" NPT		
57P-GE-08LN06	MALE STUD COUPLINGS 08mm X 3/8" NPT		
57P-GE-10LN04	MALE STUD COUPLINGS 10mm X 1/4" NPT		
57P-GE-10LN06	MALE STUD COUPLINGS 10mm X 3/8" NPT		
57P-GE-10LN08	MALE STUD COUPLINGS 10mm X 1/2" NPT		
57P-GE-12LN04	MALE STUD COUPLINGS 12mm X 1/4" NPT		
57P-GE-12LN06	MALE STUD COUPLINGS 12mm X 3/8" NPT		
57P-GE-12LN08	MALE STUD COUPLINGS 12mm X 1/2" NPT		
57P-GE-15LN06	MALE STUD COUPLINGS 15mm X 3/8" NPT		
57P-GE-15LN08	MALE STUD COUPLINGS 15mm X 1/2" NPT		
57P-GE-18LN08	MALE STUD COUPLINGS 18mm X 1/2" NPT		
57P-GE-22LN08	MALE STUD COUPLINGS 22mm X 1/2" NPT		
57P-GE-22LN12	MALE STUD COUPLINGS 22mm X 3/4" NPT		
57P-GE-28LN16	MALE STUD COUPLINGS 28mm X 1" NPT		
57P-GE-35LN20	MALE STUD COUPLINGS 35mm X 1-1/4" NPT		
57P-GE-42LN24	MALE STUD COUPLINGS 42mm X 1-1/2" NPT		

STEEL TUBE FITTINGS

Retail
Prices

MALE STUD COUPLINGS BSP WITH CAPTIVE ED SEAL L SERIES

01-10-2022

Part No	Description	Visual	Retail
57P-GE-06LR02ED	MALE STUD COUPLINGS 06mm X 1/8" BSP ED SEAL		
57P-GE-06LR04ED	MALE STUD COUPLINGS 06mm X 1/4" BSP ED SEAL		
57P-GE-08LR02ED	MALE STUD COUPLINGS 08mm X 1/8" BSP ED SEAL		
57P-GE-08LR04ED	MALE STUD COUPLINGS 08mm X 1/4" BSP ED SEAL		
57P-GE-08LR06ED	MALE STUD COUPLINGS 08mm X 3/8" BSP ED SEAL		
57P-GE-10LR04ED	MALE STUD COUPLINGS 10mm X 1/4" BSP ED SEAL		
57P-GE-10LR06ED	MALE STUD COUPLINGS 10mm X 3/8" BSP ED SEAL		
57P-GE-10LR08ED	MALE STUD COUPLINGS 10mm X 1/2" BSP ED SEAL		
57P-GE-12LR04ED	MALE STUD COUPLINGS 12mm X 1/4" BSP ED SEAL		
57P-GE-12LR06ED	MALE STUD COUPLINGS 12mm X 3/8" BSP ED SEAL		
57P-GE-12LR08ED	MALE STUD COUPLINGS 12mm X 1/2" BSP ED SEAL		
57P-GE-12LR12ED	MALE STUD COUPLINGS 12mm X 3/4" BSP ED SEAL		
57P-GE-15LR06ED	MALE STUD COUPLINGS 15mm X 3/8" BSP ED SEAL		
57P-GE-15LR08ED	MALE STUD COUPLINGS 15mm X 1/2" BSP ED SEAL		
57P-GE-15LR12ED	MALE STUD COUPLINGS 15mm X 3/4" BSP ED SEAL		
57P-GE-18LR08ED	MALE STUD COUPLINGS 18mm X 1/2" BSP ED SEAL		
57P-GE-18LR12ED	MALE STUD COUPLINGS 18mm X 3/4" BSP ED SEAL		
57P-GE-22LR08ED	MALE STUD COUPLINGS 22mm X 1/2" BSP ED SEAL		
57P-GE-22LR12ED	MALE STUD COUPLINGS 22mm X 3/4" BSP ED SEAL		
57P-GE-28LR12ED	MALE STUD COUPLINGS 28mm X 3/4" BSP ED SEAL		
57P-GE-28LR16ED	MALE STUD COUPLINGS 28mm X 1" BSP ED SEAL		
57P-GE-35LR20ED	MALE STUD COUPLINGS 35mm X 1-1/4" BSP ED SEAL		
57P-GE-42LR24ED	MALE STUD COUPLINGS 42mm X 1-1/2" BSP ED SEAL		

MALE STUD COUPLINGS METRIC WITH CAPTIVE ED SEAL L SERIES

Part No	Description	Visual	Retail
57P-GE-06LMED	MALE STUD COUPLING 06mm X M10X1 METRIC ED SEAL		
57P-GE-08LMED	MALE STUD COUPLING 08mm X M12X1.5 METRIC ED SEAL		
57P-GE-10LMED	MALE STUD COUPLING 10mm X M14X1.5 METRIC ED SEAL		
57P-GE-12LMED	MALE STUD COUPLING 12mm X M16X1.5 METRIC ED SEAL		
57P-GE-15LMED	MALE STUD COUPLING 15mm X M18X1.5 METRIC ED SEAL		
57P-GE-18LMED	MALE STUD COUPLING 18mm X M22X1.5 METRIC ED SEAL		
57P-GE-22LMED	MALE STUD COUPLING 22mm X M26X1.5 METRIC ED SEAL		
57P-GE-28LMED	MALE STUD COUPLING 28mm X M33X2 METRIC ED SEAL		
57P-GE-35LMED	MALE STUD COUPLING 35mm X M42X2 METRIC ED SEAL		
57P-GE-42LMED	MALE STUD COUPLING 42mm X M48X2 METRIC ED SEAL		

STEEL TUBE FITTINGS

Retail

Prices

MALE STUD COUPLINGS BSP WITH CAPTIVE ED SEAL S SERIES

01-10-2022

Part No	Description	Visual	Retail	
57P-GE-06SR04ED	MALE STUD COUPLING 06mm X 1/4" BSP ED SEAL			
57P-GE-08SR04ED	MALE STUD COUPLING 08mm X 1/4" BSP ED SEAL			
57P-GE-10SR06ED	MALE STUD COUPLING 10mm X 3/8" BSP ED SEAL			
57P-GE-12SR06ED	MALE STUD COUPLING 12mm X 3/8" BSP ED SEAL			
57P-GE-14SR08ED	MALE STUD COUPLING 14mm X 1/2" BSP ED SEAL			
57P-GE-16SR08ED	MALE STUD COUPLING 16mm X 1/2" BSP ED SEAL			
57P-GE-20SR12ED	MALE STUD COUPLING 20mm X 3/4" BSP ED SEAL			
57P-GE-25SR16ED	MALE STUD COUPLING 25mm X 1" BSP ED SEAL			
57P-GE-30SR20ED	MALE STUD COUPLING 30mm X 1 1/4" BSP ED SEAL			
57P-GE-38SR24ED	MALE STUD COUPLING 38mm X 1 1/2" BSP ED SEAL			

MALE STUD COUPLINGS METRIC WITH CAPTIVE ED SEAL S SERIES

Part No	Description	Visual	Retail	
57P-GE-06SMED	MALE STUD COUPLING 06mm X M12X1.5			
57P-GE-08SMED	MALE STUD COUPLING 08mm X M14X1.5			
57P-GE-10SMED	MALE STUD COUPLING 10mm X M16X1.5			
57P-GE-12SMED	MALE STUD COUPLING 12mm X M18X1.5			
57P-GE-14SMED	MALE STUD COUPLING 14mm X M20X1.5			
57P-GE-16SMED	MALE STUD COUPLING 16mm X M22X1.5			
57P-GE-20SMED	MALE STUD COUPLING 20mm X M27X2			
57P-GE-25SMED	MALE STUD COUPLING 25mm X M33X2			
57P-GE-30SMED	MALE STUD COUPLING 30mm X M42X2			
57P-GE-38SMED	MALE STUD COUPLING 38mm X M48X2			

STEEL TUBE FITTINGS

Retail

Prices

MALE STUD COUPLINGS NPT S SERIES

01-10-2022

Part No	Description	Visual	Retail
57P-GE-06SN04	MALE STUD COUPLINGS 06 mm X 1/4" NPT		
57P-GE-08SN04	MALE STUD COUPLINGS 08 mm X 1/4" NPT		
57P-GE-10SN04	MALE STUD COUPLINGS 10 mm X 1/4" NPT		
57P-GE-10SN06	MALE STUD COUPLINGS 10 mm X 3/8" NPT		
57P-GE-10SN08	MALE STUD COUPLINGS 10 mm X 1/2" NPT		
57P-GE-12SN04	MALE STUD COUPLINGS 12 mm X 1/4" NPT		
57P-GE-12SN06	MALE STUD COUPLINGS 12 mm X 3/8" NPT		
57P-GE-12SN08	MALE STUD COUPLINGS 12 mm X 1/2" NPT		
57P-GE-14SN08	MALE STUD COUPLINGS 14 mm X 1/2" NPT		
57P-GE-16SN06	MALE STUD COUPLINGS 16 mm X 3/8" NPT		
57P-GE-16SN08	MALE STUD COUPLINGS 16 mm X 1/2" NPT		
57P-GE-16SN12	MALE STUD COUPLINGS 16 mm X 3/4" NPT		
57P-GE-20SN08	MALE STUD COUPLINGS 20 mm X 1/2" NPT		
57P-GE-20SN12	MALE STUD COUPLINGS 20 mm X 3/4" NPT		
57P-GE-20SN16	MALE STUD COUPLINGS 20 mm X 1" NPT		
57P-GE-25SN12	MALE STUD COUPLINGS 25 mm X 3/4" NPT		

STRAIGHT REDUCING COUPLER L SERIES

Retail

57P-GR-08-06L	STRAIGHT REDUCING COUPLER 08/06 mm			
57P-GR-10-06L	STRAIGHT REDUCING COUPLER 10/06 mm			
57P-GR-10-08L	STRAIGHT REDUCING COUPLER 10/08 mm			
57P-GR-12-06L	STRAIGHT REDUCING COUPLER 12/06 mm			
57P-GR-12-08L	STRAIGHT REDUCING COUPLER 12/08 mm			
57P-GR-12-10L	STRAIGHT REDUCING COUPLER 12/10 mm			
57P-GR-15-06L	STRAIGHT REDUCING COUPLER 15/06 mm			
57P-GR-15-08L	STRAIGHT REDUCING COUPLER 15/08 mm			
57P-GR-15-10L	STRAIGHT REDUCING COUPLER 15/10 mm			
57P-GR-15-12L	STRAIGHT REDUCING COUPLER 15/12 mm			
57P-GR-18-08L	STRAIGHT REDUCING COUPLER 18/08 mm			
57P-GR-18-10L	STRAIGHT REDUCING COUPLER 18/10 mm			
57P-GR-18-12L	STRAIGHT REDUCING COUPLER 18/12 mm			
57P-GR-18-15L	STRAIGHT REDUCING COUPLER 18/15 mm			
57P-GR-22-12L	STRAIGHT REDUCING COUPLER 22/15 mm			
57P-GR-22-15L	STRAIGHT REDUCING COUPLER 22/15 mm			
57P-GR-22-18L	STRAIGHT REDUCING COUPLER 22/18 mm			
57P-GR-28-15L	STRAIGHT REDUCING COUPLER 28/15 mm			
57P-GR-28-18L	STRAIGHT REDUCING COUPLER 28/18 mm			
57P-GR-28-22L	STRAIGHT REDUCING COUPLER 28/22 mm			
57P-GR-35-22L	STRAIGHT REDUCING COUPLER 35/22 mm			
57P-GR-35-28L	STRAIGHT REDUCING COUPLER 35/28 mm			

STEEL TUBE FITTINGS

Retail

Prices

STRAIGHT REDUCING COUPLER S SERIES

19-07-2023

Part No	Description		Visual	Retail
57P-GR-08-06S	STRAIGHT REDUCING COUPLER 08/06 mm			
57P-GR-10-06S	STRAIGHT REDUCING COUPLER 10/06 mm			
57P-GR-10-08S	STRAIGHT REDUCING COUPLER 10/08 mm			
57P-GR-12-06S	STRAIGHT REDUCING COUPLER 12/06 mm			
57P-GR-12-08S	STRAIGHT REDUCING COUPLER 12/08 mm			
57P-GR-12-10S	STRAIGHT REDUCING COUPLER 12/10 mm			
57P-GR-14-10S	STRAIGHT REDUCING COUPLER 14/10 mm			
57P-GR-14-12S	STRAIGHT REDUCING COUPLER 14/12 mm			
57P-GR-16-10S	STRAIGHT REDUCING COUPLER 16/10 mm			
57P-GR-16-12S	STRAIGHT REDUCING COUPLER 16/12 mm			
57P-GR-16-14S	STRAIGHT REDUCING COUPLER 16/14 mm			
57P-GR-20-10S	STRAIGHT REDUCING COUPLER 20/10 mm			
57P-GR-20-12S	STRAIGHT REDUCING COUPLER 20/12 mm			
57P-GR-20-16S	STRAIGHT REDUCING COUPLER 20/16 mm			
57P-GR-25-16S	STRAIGHT REDUCING COUPLER 25/16 mm			
57P-GR-25-20S	STRAIGHT REDUCING COUPLER 25/20 mm			
57P-GR-30-20S	STRAIGHT REDUCING COUPLER 30/20 mm			
57P-GR-30-25S	STRAIGHT REDUCING COUPLER 30/25 mm			
57P-GR-38-30S	STRAIGHT REDUCING COUPLER 38/30 mm			

STANDPIPE REDUCER L SERIES

Part No	Description		Visual	Retail
57P-KOR-08-06L	STANDPIPE REDUCER 08 - 06 mm			
57P-KOR-10-06L	STANDPIPE REDUCER 10 - 06 mm			
57P-KOR-10-08L	STANDPIPE REDUCER 10 - 08 mm			
57P-KOR-12-06L	STANDPIPE REDUCER 12 - 06 mm			
57P-KOR-12-08L	STANDPIPE REDUCER 12 - 08 mm			
57P-KOR-12-10L	STANDPIPE REDUCER 12 - 10 mm			
57P-KOR-15-06L	STANDPIPE REDUCER 15 - 06 mm			
57P-KOR-15-08L	STANDPIPE REDUCER 15 - 08 mm			
57P-KOR-15-10L	STANDPIPE REDUCER 15 - 10 mm			
57P-KOR-15-12L	STANDPIPE REDUCER 15 - 12 mm			
57P-KOR-18-06L	STANDPIPE REDUCER 18 - 06 mm			
57P-KOR-18-08L	STANDPIPE REDUCER 18 - 08 mm			
57P-KOR-18-10L	STANDPIPE REDUCER 18 - 10 mm			
57P-KOR-18-12L	STANDPIPE REDUCER 18 - 12 mm			
57P-KOR-18-15L	STANDPIPE REDUCER 18 - 15 mm			
57P-KOR-22-06L	STANDPIPE REDUCER 22 - 06 mm			
57P-KOR-22-08L	STANDPIPE REDUCER 22 - 08 mm			
57P-KOR-22-10L	STANDPIPE REDUCER 22 - 10 mm			
57P-KOR-22-12L	STANDPIPE REDUCER 22 - 12 mm			
57P-KOR-22-15L	STANDPIPE REDUCER 22 - 15 mm			
57P-KOR-22-18L	STANDPIPE REDUCER 22 - 18 mm			
57P-KOR-28-12L	STANDPIPE REDUCER 28 - 12 mm			
57P-KOR-28-15L	STANDPIPE REDUCER 28 - 15 mm			
57P-KOR-28-18L	STANDPIPE REDUCER 28 - 18 mm			
57P-KOR-28-22L	STANDPIPE REDUCER 28 - 22 mm			
57P-KOR-35-15L	STANDPIPE REDUCER 35 - 15 mm			
57P-KOR-35-18L	STANDPIPE REDUCER 35 - 18 mm			
57P-KOR-35-22L	STANDPIPE REDUCER 35 - 22 mm			
57P-KOR-35-28L	STANDPIPE REDUCER 35 - 28 mm			
57P-KOR-42-15L	STANDPIPE REDUCER 42 - 15 mm			
57P-KOR-42-18L	STANDPIPE REDUCER 42 - 18 mm			
57P-KOR-42-22L	STANDPIPE REDUCER 42 - 22 mm			
57P-KOR-42-28L	STANDPIPE REDUCER 42 - 28 mm			
57P-KOR-42-35L	STANDPIPE REDUCER 42 - 35 mm			

STEEL TUBE FITTINGS

Retail

Prices

RETAINING NUTS

01-10-2022

Part No	Description		Visual	Retail
57P-M-04LL	RETAINING NUTS 04 mm X M08 X 1			
57P-M-06LL	RETAINING NUTS 06 mm X M10 X 1			
57P-M-08LL	RETAINING NUTS 08 mm X M12 X 1			
57P-M-16LL	RETAINING NUTS 16 mm X M20 X1.5			
57P-M-06L	RETAINING NUTS 06 mm X M12 X 1.5			
57P-M-08L	RETAINING NUTS 08 mm X M14 X 1.5			
57P-M-10L	RETAINING NUTS 10 mm X M16 X 1.5			
57P-M-12L	RETAINING NUTS 12 mm X M18 X 1.5			
57P-M-15L	RETAINING NUTS 15 mm X M22 X 1.5			
57P-M-18L	RETAINING NUTS 18 mm X M26 X 1.5			
57P-M-22L	RETAINING NUTS 22 mm X M30 X 2			
57P-M-28L	RETAINING NUTS 28 mm X M36 X 2			
57P-M-35L	RETAINING NUTS 35 mm X M45 X 2			
57P-M-42L	RETAINING NUTS 42 mm X M52 X 2			
57P-M-06S	RETAINING NUTS 06 mm X M12 X 1.5			
57P-M-08S	RETAINING NUTS 08 mm X M14 X 1.5			
57P-M-10S	RETAINING NUTS 10 mm X M16 X 1.5			
57P-M-12S	RETAINING NUTS 12 mm X M18 X 1.5			
57P-M-14S	RETAINING NUTS 14 mm X M22 X 1.5			
57P-M-16S	RETAINING NUTS 16 mm X M24 X 1.5			
57P-M-20S	RETAINING NUTS 20 mm X M30 X 2			
57P-M-25S	RETAINING NUTS 25 mm X M36 X 2			
57P-M-30S	RETAINING NUTS 30 mm X M42 X 2			
57P-M-38S	RETAINING NUTS 38 mm X M52 X 2			

PRESSURE GAUGE CONNECTORS

Part No	Description		Visual	Retail	
57P-MAV-06LR	PRESSURE GAUGE CONNECTORS 06mm X 1/4"				
57P-MAV-08LR	PRESSURE GAUGE CONNECTORS 08mm X 1/4"				
57P-MAV-10LR	PRESSURE GAUGE CONNECTORS 10mm X 1/4"				
57P-MAV-12LR	PRESSURE GAUGE CONNECTORS 12mm X 1/4"				
57P-MAV-06SR	PRESSURE GAUGE CONNECTORS 06mm X 1/2"				
57P-MAV-08SR	PRESSURE GAUGE CONNECTORS 08mm X 1/2"				
57P-MAV-10SR	PRESSURE GAUGE CONNECTORS 10mm X 1/2"				
57P-MAV-12SR	PRESSURE GAUGE CONNECTORS 12mm X 1/2"				
57P-MAV-EV06LR	PRESSURE GAUGE CONNECTORS 06mm X 1/4"				
57P-MAV-EV08LR	PRESSURE GAUGE CONNECTORS 08mm X 1/4"				
57P-MAV-EV10LR	PRESSURE GAUGE CONNECTORS 10mm X 1/4"				
57P-MAV-EV12LR	PRESSURE GAUGE CONNECTORS 12mm X 1/4"				
57P-MAV-EV06SR	PRESSURE GAUGE CONNECTORS 06mm X 1/2"				
57P-MAV-EV08SR	PRESSURE GAUGE CONNECTORS 08mm X 1/2"				
57P-MAV-EV10SR	PRESSURE GAUGE CONNECTORS 10mm X 1/2"				

STEEL TUBE FITTINGS

Retail

Prices

NON-RETURN VALVES

01-10-2022

Part No	Description	Visual	Retail	
57P-RHD-12L	NON-RETURN VALVES 12 mm			
57P-RHD-15L	NON-RETURN VALVES 15 mm			
57P-RHD-18L	NON-RETURN VALVES 18 mm			
57P-RHD-22L	NON-RETURN VALVES 22 mm			
57P-RHD-28L	NON-RETURN VALVES 28 mm			
57P-RHD-35L	NON-RETURN VALVES 35 mm			
57P-RHD-42L	NON-RETURN VALVES 42 mm			
57P-RHD-12S	NON-RETURN VALVES 12 mm			
57P-RHD-14S	NON-RETURN VALVES 14 mm			
57P-RHD-16S	NON-RETURN VALVES 16 mm			
57P-RHD-20S	NON-RETURN VALVES 20 mm			
57P-RHD-25S	NON-RETURN VALVES 25 mm			
57P-RHD-30S	NON-RETURN VALVES 30 mm			
57P-RHD-38S	NON-RETURN VALVES 38 mm			

MALE/FEMALE THREAD REDUCING ADAPTORS

Part No	Description	Visual	Retail
57P-RI-02-04	MALE/FEMALE REDUCING 1/8 - 1/4		
57P-RI-02-06	MALE/FEMALE REDUCING 1/8 - 3/8		
57P-RI-04-02	MALE/FEMALE REDUCING 1/4 - 1/8		
57P-RI-04-06	MALE/FEMALE REDUCING 1/4 - 3/8		
57P-RI-04-08	MALE/FEMALE REDUCING 1/4 - 1/2		
57P-RI-04-12	MALE/FEMALE REDUCING 1/4 - 3/4		
57P-RI-06-02	MALE/FEMALE REDUCING 3/8 - 1/8		
57P-RI-06-04	MALE/FEMALE REDUCING 3/8 - 1/4		
57P-RI-06-08	MALE/FEMALE REDUCING 3/8 - 1/2		
57P-RI-06-12	MALE/FEMALE REDUCING 3/8 - 3/4		
57P-RI-08-02	MALE/FEMALE REDUCING 1/2 - 1/8		
57P-RI-08-04	MALE/FEMALE REDUCING 1/2 - 1/4		
57P-RI-08-06	MALE/FEMALE REDUCING 1/2 - 3/8		
57P-RI-08-12	MALE/FEMALE REDUCING 1/2 - 3/4		
57P-RI-08-16	MALE/FEMALE REDUCING 1/2 - 1		
57P-RI-08-20	MALE/FEMALE REDUCING 1/2 - 1 1/4		
57P-RI-12-04	MALE/FEMALE REDUCING 3/4 - 1/4		
57P-RI-12-06	MALE/FEMALE REDUCING 3/4 - 3/8		
57P-RI-12-08	MALE/FEMALE REDUCING 3/4 - 1/2		
57P-RI-12-16	MALE/FEMALE REDUCING 3/4 - 1		
57P-RI-12-20	MALE/FEMALE REDUCING 3/4 - 1 1/4		
57P-RI-12-24	MALE/FEMALE REDUCING 3/4 - 1 1/2		
57P-RI-16-04	MALE/FEMALE REDUCING 1 - 1/4		
57P-RI-16-06	MALE/FEMALE REDUCING 1 - 3/8		
57P-RI-16-08	MALE/FEMALE REDUCING 1 - 1/2		
57P-RI-16-12	MALE/FEMALE REDUCING 1 - 3/4		
57P-RI-16-20	MALE/FEMALE REDUCING 1 - 1 1/4		
57P-RI-16-24	MALE/FEMALE REDUCING 1 - 1 1/2		
57P-RI-20-08	MALE/FEMALE REDUCING 1 1/4 - 1/2		
57P-RI-20-12	MALE/FEMALE REDUCING 1 1/4 - 3/4		
57P-RI-20-16	MALE/FEMALE REDUCING 1 1/4 - 1		
57P-RI-20-24	MALE/FEMALE REDUCING 1 1/4 - 1 1/2		
57P-RI-24-08	MALE/FEMALE REDUCING 1 1/2 - 1/2		
57P-RI-24-12	MALE/FEMALE REDUCING 1 1/2 - 3/4		
57P-RI-24-16	MALE/FEMALE REDUCING 1 1/2 - 1		
57P-RI-24-20	MALE/FEMALE REDUCING 1 1/2 - 1 1/4		

STEEL TUBE FITTINGS

Retail

Prices

EQUAL ELBOW

01-10-2022

Part No	Description		Visual	Retail
57P-W-06LL	EQUAL ELBOW 06 mm			
57P-W-06L	EQUAL ELBOW 06 mm			
57P-W-08L	EQUAL ELBOW 08 mm			
57P-W-10L	EQUAL ELBOW 10 mm			
57P-W-12L	EQUAL ELBOW 12 mm			
57P-W-15L	EQUAL ELBOW 15 mm			
57P-W-18L	EQUAL ELBOW 18 mm			
57P-W-22L	EQUAL ELBOW 22 mm			
57P-W-28L	EQUAL ELBOW 28 mm			
57P-W-35L	EQUAL ELBOW 35 mm			
57P-W-42L	EQUAL ELBOW 42 mm			
57P-W-06S	EQUAL ELBOW 06 mm			
57P-W-08S	EQUAL ELBOW 08 mm			
57P-W-10S	EQUAL ELBOW 10 mm			
57P-W-12S	EQUAL ELBOW 12 mm			
57P-W-14S	EQUAL ELBOW 14 mm			
57P-W-16S	EQUAL ELBOW 16 mm			
57P-W-20S	EQUAL ELBOW 20 mm			
57P-W-25S	EQUAL ELBOW 25 mm			
57P-W-30S	EQUAL ELBOW 30 mm			

MALE STUD COUPLINGS (NPT) L & S SERIES

Part No	Description		Visual	Retail
57P-WE-04LLN02	MALE STUD COUPLINGS 04mm X 1/8" NPT			
57P-WE-06LLN02	MALE STUD COUPLINGS 06mm X 1/8" NPT			
57P-WE-08LLN02	MALE STUD COUPLINGS 08mm X 1/8" NPT			
57P-WE-06LN02	MALE STUD COUPLINGS 06mm X 1/8" NPT			
57P-WE-06LN04	MALE STUD COUPLINGS 06mm X 1/4" NPT			
57P-WE-08LN02	MALE STUD COUPLINGS 08mm X 1/8" NPT			
57P-WE-08LN04	MALE STUD COUPLINGS 08mm X 1/4" NPT			
57P-WE-10LN04	MALE STUD COUPLINGS 10mm X 1/4" NPT			
57P-WE-10LN06	MALE STUD COUPLINGS 10mm X 3/8" NPT			
57P-WE-10LN08	MALE STUD COUPLINGS 10mm X 1/2" NPT			
57P-WE-12LN04	MALE STUD COUPLINGS 12mm X 1/4" NPT			
57P-WE-12LN06	MALE STUD COUPLINGS 12mm X 3/8" NPT			
57P-WE-12LN08	MALE STUD COUPLINGS 12mm X 1/2" NPT			
57P-WE-15LN06	MALE STUD COUPLINGS 15mm X 3/8" NPT			
57P-WE-15LN08	MALE STUD COUPLINGS 15mm X 1/2" NPT			
57P-WE-18LN08	MALE STUD COUPLINGS 18mm X 1/2" NPT			
57P-WE-22LN08	MALE STUD COUPLINGS 22mm X 1/2" NPT			
57P-WE-22LN12	MALE STUD COUPLINGS 22mm X 3/4" NPT			
57P-WE-28LN16	MALE STUD COUPLINGS 28mm X 1" NPT			
57P-WE-35LN20	MALE STUD COUPLINGS 35mm X 1 1/4" NPT			
57P-WE-42LN24	MALE STUD COUPLINGS 42mm X 1 1/2" NPT			
57P-WE-06SN02	MALE STUD COUPLINGS 06mm X 1/8" NPT			
57P-WE-08SN04	MALE STUD COUPLINGS 08mm X 1/4" NPT			
57P-WE-10SN04	MALE STUD COUPLINGS 10mm X 1/4" NPT			
57P-WE-12SN06	MALE STUD COUPLINGS 12mm X 3/8" NPT			
57P-WE-14SN08	MALE STUD COUPLINGS 14mm X 1/2" NPT			
57P-WE-16SN08	MALE STUD COUPLINGS 16mm X 1/2" NPT			
57P-WE-20SN12	MALE STUD COUPLINGS 20mm X 3/4" NPT			
57P-WE-25SN16	MALE STUD COUPLINGS 25mm X 1" NPT			
57P-WE-30SN20	MALE STUD COUPLINGS 30mm X 1 1/4" NPT			
57P-WE-38SN24	MALE STUD COUPLINGS 38mm X 1 1/2" NPT			

STEEL TUBE CLAMPS

Retail

Prices

LIGHT DUTY PIPE CLAMPS

01-10-2022

Part No	Description		Visual	Retail
57P-ICL-106	LIGHT DUTY PIPE CLAMPS 6mm			
57P-ICL-108	LIGHT DUTY PIPE CLAMPS 8mm			
57P-ICL-110	LIGHT DUTY PIPE CLAMPS 10mm			
57P-ICL-112	LIGHT DUTY PIPE CLAMPS 12mm			
57P-ICL-214	LIGHT DUTY PIPE CLAMPS 14mm			
57P-ICL-215	LIGHT DUTY PIPE CLAMPS 15mm			
57P-ICL-216	LIGHT DUTY PIPE CLAMPS 16mm			
57P-ICL-218	LIGHT DUTY PIPE CLAMPS 18mm			
57P-ICL-320	LIGHT DUTY PIPE CLAMPS 20mm			
57P-ICL-322	LIGHT DUTY PIPE CLAMPS 22mm			
57P-ICL-325	LIGHT DUTY PIPE CLAMPS 25mm			
57P-ICL-328	LIGHT DUTY PIPE CLAMPS 28mm			
57P-ICL-330	LIGHT DUTY PIPE CLAMPS 30mm			
57P-ICL-532	LIGHT DUTY PIPE CLAMPS 32mm			
57P-ICL-535	LIGHT DUTY PIPE CLAMPS 35mm			
57P-ICL-538	LIGHT DUTY PIPE CLAMPS 38mm			
57P-ICL-542	LIGHT DUTY PIPE CLAMPS 42mm			
57P-ICL-548	LIGHT DUTY PIPE CLAMPS 48mm			
57P-ICL-550	LIGHT DUTY PIPE CLAMPS 50mm			
57P-ICL-560	LIGHT DUTY PIPE CLAMPS 60mm			

HEAVY DUTY PIPE CLAMPS

Part No	Description		Visual	Retail
57P-ICH-106	HEAVY DUTY PIPE CLAMPS 6mm			
57P-ICH-108	HEAVY DUTY PIPE CLAMPS 8mm			
57P-ICH-110	HEAVY DUTY PIPE CLAMPS 10mm			
57P-ICH-112	HEAVY DUTY PIPE CLAMPS 12mm			
57P-ICH-214	HEAVY DUTY PIPE CLAMPS 14mm			
57P-ICH-215	HEAVY DUTY PIPE CLAMPS 15mm			
57P-ICH-216	HEAVY DUTY PIPE CLAMPS 16mm			
57P-ICH-218	HEAVY DUTY PIPE CLAMPS 18mm			
57P-ICH-320	HEAVY DUTY PIPE CLAMPS 20mm			
57P-ICH-322	HEAVY DUTY PIPE CLAMPS 22mm			
57P-ICH-325	HEAVY DUTY PIPE CLAMPS 25mm			
57P-ICH-428	HEAVY DUTY PIPE CLAMPS 28mm			
57P-ICH-430	HEAVY DUTY PIPE CLAMPS 30mm			
57P-ICH-532	HEAVY DUTY PIPE CLAMPS 32mm			
57P-ICH-535	HEAVY DUTY PIPE CLAMPS 35mm			
57P-ICH-538	HEAVY DUTY PIPE CLAMPS 38mm			
57P-ICH-542	HEAVY DUTY PIPE CLAMPS 42mm			
57P-ICH-548	HEAVY DUTY PIPE CLAMPS 48mm			
57P-ICH-550	HEAVY DUTY PIPE CLAMPS 50mm			
57P-ICH-560	HEAVY DUTY PIPE CLAMPS 60mm			

HOSE SIZE SELECTION NOMOGRAPH

Indicating Flow Capacity of Hose Assemblies At Recommended Flow Velocities.

Selecting the Right Hose Size.

With this nomograph, you can easily select the correct Hose ID size, Desired Flow Rate and Recommended Flow Velocity.

If any two of these factors are known, the third can be determined.

To use this nomograph:

1. Pick the two known values.
2. Lay a straightedge to intersect the two values.
3. Intersection on the third vertical line gives the value of that factor.

Example: To find the bore size for a Pressure Line consistent with a Flow Rate of 100 litres per minute (26 US or 22 Imperial gallons per minute), and a Flow Velocity of 4,5 metres per second

Answer: The line crosses Hose Bore between -12 and -16 so use a -16 hose

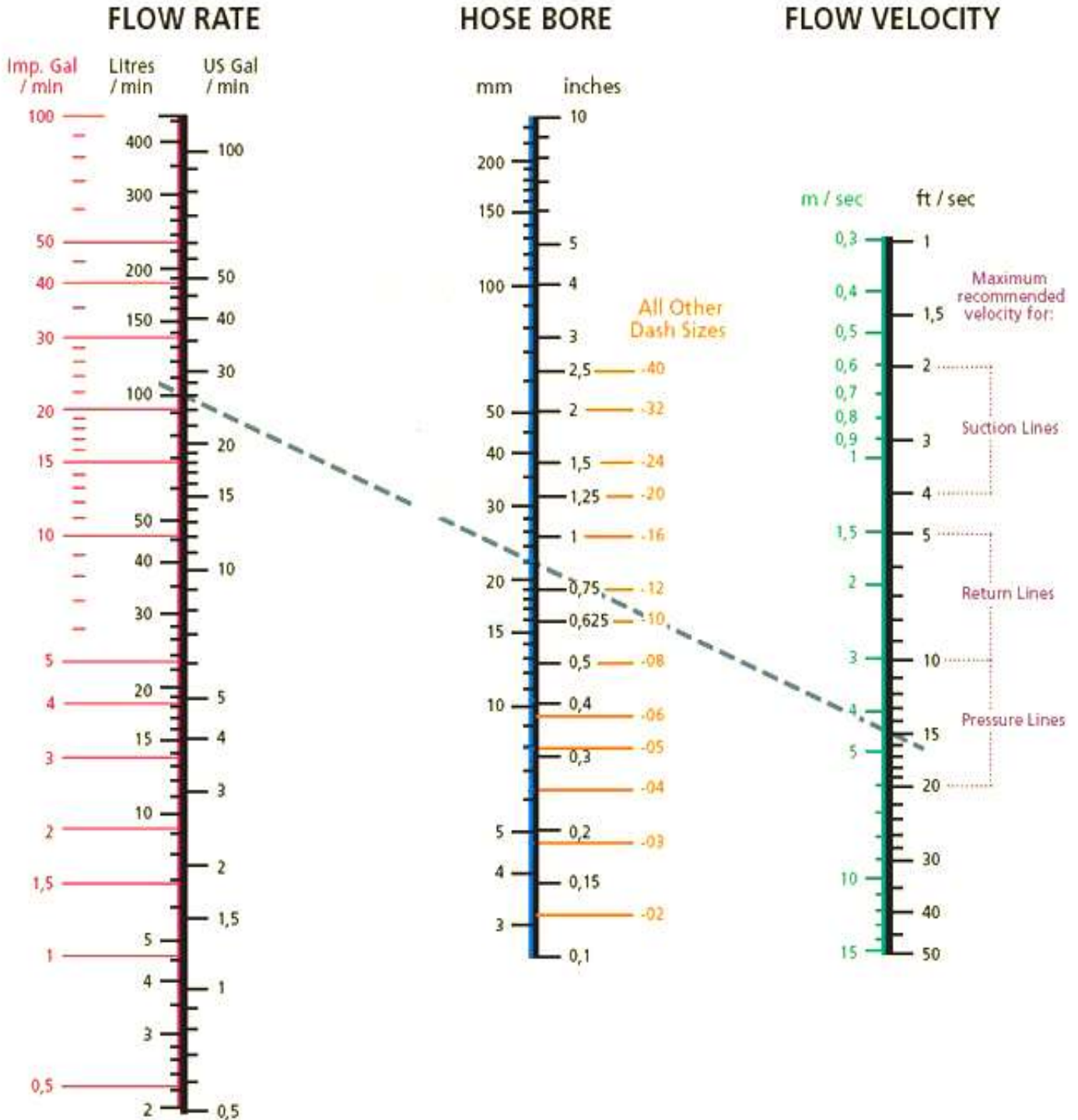

The velocity of the fluid should not exceed the range shown in the right hand column. When oil velocities are higher than recommended in the chart, turbulent flow occurs, resulting in loss of pressure and excessive heating. For long hoses and/or high viscosity oil, or if the flow of hydraulic fluid is continuous, it is recommended to use figures at the lower end of the Maximum Recommended Velocity range. For short hoses and/or low viscosity oil, or if the flow of hydraulic fluid is intermittent or for only short periods of time, figures at the higher end of the Maximum Recommended Velocity range can be used.

STANDARD PUMP PORTS

BSPP THREADED PORTS

PORT SIZE	THREAD	THREAD OD	DRILL SIZE
1/8"	1/8" - 28 tpi	9.5	8.8
1/4"	1/4" - 19 tpi	13	11.8
3/8"	3/8" - 19 tpi	16.5	15.5
1/2"	1/2" - 14 tpi	21	19
5/8"	5/8" - 14 tpi	22.7	21
3/4"	3/4" - 14 tpi	26.2	24.5
1"	1" - 11 tpi	33	31
1-1/4"	1-1/4" - 11 tpi	41.8	40
1-1/2"	1-1/2" - 11 tpi	47.4	45.5
2"	2" - 11 tpi	59.3	57

BOSCH SQUARE FLANGED PORTS

PORT SIZE mm	P C D mm	THREAD mm	DRILL SIZE
8	30	M6 x 1	5
12	30	M6 x 1	5
15	35	M6 x 1	5
20	40	M6 x 1	5
18	55	M8 x 1.25	6.5
26	55	M8 x 1.25	6.5

DIAMOND FLANGED PORTS

PORT SIZE	THREAD	THREAD OD	DRILL SIZE
1/8"	1/8" - 27 tpi	9.2	8.8
1/4"	1/4" - 18 tpi	13	10.7
3/8"	3/8" - 18 tpi	16.4	14.25
1/2"	1/2" - 14 tpi	20.5	17.5
3/4"	3/4" - 14 tpi	25.7	22.75
1"	1" - 11-1/2"	31.5	28.5
1-1/4"	1-1/4" - 11-1/2"	41.3	37.5
1-1/2"	1-1/2" - 11-1/2"	47.3	43.5
2"	2" - 11-1/2"	59.5	55

NPT THREADED PORTS

PORT SIZE mm	P C D mm	THREAD mm	DRILL SIZE
13	30	M6 x 1	5
19	40	M8 x 1.25	6.5
27	51	M10 x 1.5	8.5
34	56	M10 x 1.5	8.5
36	62	M10 x 1.5	8.5
45	72	M12 x 1.75	10

S.A.E 4 BOLT FLANGE 3000 SERIES

PORT SIZE	THREAD	THREAD OD	DRILL SIZE
1/4"	7/16" - 20UNF	11	9.9
5/8"	1/2" - 20 UNF	12.5	11.6
3/8"	9/16" - 18UNF	14	13
1/2"	3/4" - 16UNF	19	17.5
5/8"	7/8" - 14UNF	22	20.5
3/4"	1" - 1/16- 12UN	26.8	24.5
1"	1" - 5/16- 12UN	32.2	31.2
1 1/4"	1" - 5/8 - 12UN	41	39
1 1/2"	1" - 7/8 - 12UN	47.2	45.5
2"	2" - 1/2 - 12UN	63	61

FLANGE SIZE	DIMENSIONS			SCREWS			
	C	E	H	METRIC	DRILL	UNC	DRILL
1/2"	38.1	17.48	16	M08	6.50	5/16	6.50
3/4"	47.63	22.23	18	M10	8.50	3/8	8.00
1"	52.37	26.19	18	M10	8.50	3/8	8.00
1 1/4"	58.72	30.18	21	M10	8.50	7/16	9.50
1 1/2"	69.85	35.71	25	M12	10.00	1/2	10.50
2	77.77	42.88	25	M12	10.00	1/2	10.50
2 1/2"	88.9	50.80	25	M12	10.00	1/2	10.50
3"	106.38	61.93	27	M16	14.00	5/8	13.50
3 1/2"	120.65	69.85	27	M16	14.00	5/8	13.50
4"	130.18	77.77	27	M16	14.00	5/8	13.50

S. A. E. "O" THREADED PORTS

PORT SIZE	THREAD	THREAD OD	DRILL SIZE
1/4"	7/16" - 20UNF	11	9.9
5/8"	1/2" - 20 UNF	12.5	11.6
3/8"	9/16" - 18UNF	14	13
1/2"	3/4" - 16UNF	19	17.5
5/8"	7/8" - 14UNF	22	20.5
3/4"	1" - 1/16- 12UN	26.8	24.5
1"	1" - 5/16- 12UN	32.2	31.2
1 1/4"	1" - 5/8 - 12UN	41	39
1 1/2"	1" - 7/8 - 12UN	47.2	45.5
2"	2" - 1/2 - 12UN	63	61

S.A.E 4 BOLT FLANGE 6000 SERIES

FLANGE SIZE	DIMENSIONS			SCREWS			
	C	E	H	METRIC	DRILL	UNC	DRILL
1/2"	40.49	18.24	16	M08	6.50	5/16	6.50
3/4"	50.80	23.80	21	M10	8.50	3/8	8.00
1"	57.15	27.76	25	M12	10.00	7/16	9.50
1 1/4"	66.68	31.75	27	M14	12.00	1/2	10.50
1 1/2"	79.38	36.50	30	M16	14.00	5/8	13.50
2"	96.82	44.45	37	M20	17.50	3/4	16.50

DOWTY FLANGED PORTS

PORT SIZE	P C D mm	THREAD mm	DRILL SIZE
P1 17.3	43	5/16" - 18UNC	6.6
P1 17.3	43	5/16" - 18UNC	6.6
P2 21.6	48	5/16" - 18UNC	6.6
P2 21.7	48	5/16" - 18UNC	6.6

DIAMOND PORTS

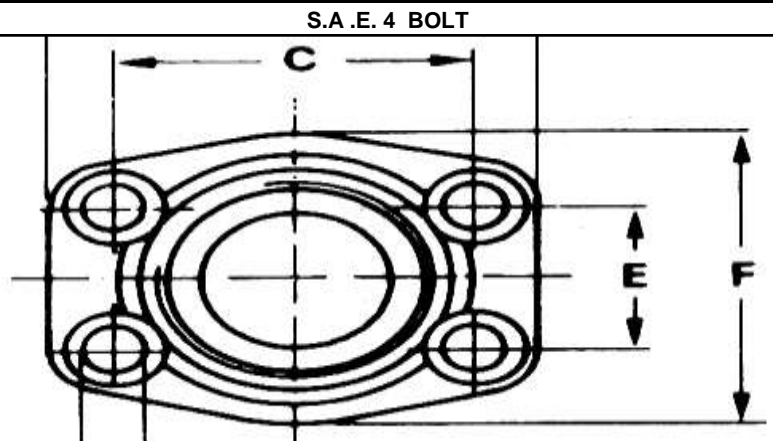

PLEASE NOTE: ALL O.E.M. NAMES OR NUMBERS ARE FOR REFERENCE USE ONLY

